

Uni-Blinds®

Innovation comes built-in



BRINGING
GLAZING
TO LIFE.

Morley
GLASS & GLAZING LTD

ScreenLine® | A brand of
pellini industrie

STEP UP TO EXCEPTIONAL WINDOWS AND DOORS



With a passionate commitment to customer service and manufacturing excellence, Morley Glass is the name thousands of customers know they can depend on for high quality glazing, sealed units and integral blinds. You can explore our complete range of products and services in this one-stop guide, and learn about what we do to ensure delight for both homeowner and installer.





CONTENTS

| | |
|---|---------|
| Bringing Your Glazing to Life | Page 4 |
| Creating a Perfect Home | Page 6 |
| Introducing Uni-Blinds® | Page 16 |
| Our Uni-Blinds® Systems | Page 24 |
| - SV System | Page 34 |
| - C System | Page 36 |
| - S System | Page 40 |
| - W Smart | Page 42 |
| - MB System | Page 44 |
| - C & S Plissé Pleated Systems | Page 50 |
| - SL16 Slimline Systems | Page 52 |
| - Pleated Blackout System | Page 54 |
| - Commercial & Public Building Solutions | Page 56 |
| - Fire Rated Systems | Page 58 |
| Our Glazing Options | Page 60 |
| - Planitherm Total+ | Page 68 |
| - Planitherm One | Page 70 |
| - Planitherm 4S | Page 72 |
| - COOL-LITE SKN 176 II | Page 74 |
| - COOL-LITE SKN 183 | Page 76 |
| - Conservatory Glass | Page 78 |
| - Self-Cleaning Glass | Page 82 |
| - Backpainted Glass | Page 84 |
| Why Choose Morley Glass | Page 86 |



INNOVATION COMES BUILT IN





Bringing your glazing to life

Break free from the notion that all windows and doors have to be pretty much the same. Whether you are an installer or homeowner, look no further than Morley Glass for innovative ways to make your windows and doors do more than you can imagine.

We utilise the most advanced processing technology, combined with a rigorous quality control system, to manufacture glazing, sealed units and integral blinds to the highest standard. This ensures we can confidently offer amongst the longest and most credible guarantees for these products available anywhere in the glazing industry.

With Morley Glass now its 23rd year of trading, and with 19 years manufacturing ScreenLine® blinds, you can trust us when we say that we are experts in our field. We are the only UK company licensed to manufacture world-leading ScreenLine® blinds in-house. This is the foundation for our highly innovative Uni-Blinds® integral blind systems which are available in a choice of manual or electronic options to suit every property and budget.

Uni-Blinds® integral blinds with ScreenLine® inside represent the pinnacle of blinds contained within the glass. They eliminate the need for cleaning and maintenance and are available in a comprehensive choice of colour-ways.

Our integrity is assured through our membership of the British Blind and Shutter Association (BBSA) – we are in fact the only integral blind manufacturer to have this distinguished membership. And all our units are manufactured to the exacting standards laid down by the CEN Solutions BS EN 1279. T.U.V. BSEN 1279 for IGU with Fire glass products.

One of the keys to our success is our dedication to building long term relationships with industry-leading suppliers. This is the foundation for supply chain excellence and ensures we can deliver on our promise of superb quality products every time.

That's why we work only with international suppliers we can trust, and who are leaders in their respective fields including Pellini S.p.A., GLASSOLUTIONS Saint-Gobain, Technoform and Ritec.

CREATING A PERFECT HOME



WHAT MAKES A HOME?

Our homes are so much more than bricks and mortar. They are an expression of our personalities, a place to enjoy, socialise, relax in and cherish, which is why we dedicate so much of our lives to getting them right.

For many of us, installing new windows and doors is considered one of the most important steps in upgrading our home or completely transforming a property in more ambitious projects. Often this is driven by practical considerations – making the home warmer, more energy efficient, increasing security or simply because the existing windows are looking tired. But why stop there?

With high quality integral blinds and glazing that's tailored exactly to the needs of a property, new windows and doors can become an active part of a superior quality, ultra-comfortable and smart home.

Think differently about the glass that goes in your new window and door frames and you can add functionality, style and convenience with ease. Talk to Morley Glass about the possibilities and you might just be amazed!



PRIVACY

Privacy

Many of us cherish our homes because they are our space. So much of our modern lives are lived in the public domain, so it's important that we give ourselves the opportunity to stay private when we choose to.

For those of us living next to busy roads, railway tracks or overlooked by neighbouring properties, blinds are a godsend. They ensure we can choose to share as much or as little as we like with the outside world, taking a simple pleasure in being able to close out our surroundings simply and quickly.

And don't forget how important privacy is to keep our homes secure. Leaving a clear view for prying eyes when we're not at home is a bit like leaving a door unlocked. Hence, keeping our treasured possessions in our homes out of sight is a priority when it comes to home security, and blinds are the perfect way to do this.







COMFORT



Let's hear it for glass! We probably take it for granted but it is amazing in the way it allows us to fill our homes with natural light and glorious sunshine. It is no surprise that large expanses of glass, such as in bi-fold doors, sliding doors and rooflights, have gained huge popularity in recent years. But what about when sunlight is at its strongest in the height of summer, or at its weakest in mid-winter?

Did you know that there are several different types of glass that can be used in sealed units? Often windows and doors are supplied with a standard sealed unit specification, which is compliant with the Building Regulations, but probably won't be ideal for every property.

Tailoring your glazing in combination with integral blinds will ensure your home has a stable internal climate – warm all year round, without being too hot in summer, as well as draught-free. Think about the difference that glass can make to acoustic insulation too, particularly if you live near a busy road, railway or airport.

See page 60 to learn more about our glazing options.



SMART THINKING

Digital technology and ultra-connectivity has revolutionised the way we live our lives, particularly in the last 20 years. Today we benefit from smart devices that cover everything from keeping our home secure and drying our clothes to perfection, to tracking our fitness and keeping us connected with distant friends and relatives. But what about our windows and doors?

Home automation is fast becoming a must have, with a multitude of systems enabling every type of home to benefit. These give us additional security, comfort, energy efficiency and convenience by controlling connected devices so we can get on with our daily lives without ever needing to think about them.

These systems lend themselves perfectly to window and door shading. Uni-Blinds® can be easily integrated into most leading home automation systems, including Loxone, so any home can benefit from solar shading to maintain a comfortable temperature – particularly in the height of summer – as well as automated security and privacy.

Find out more on page 49.





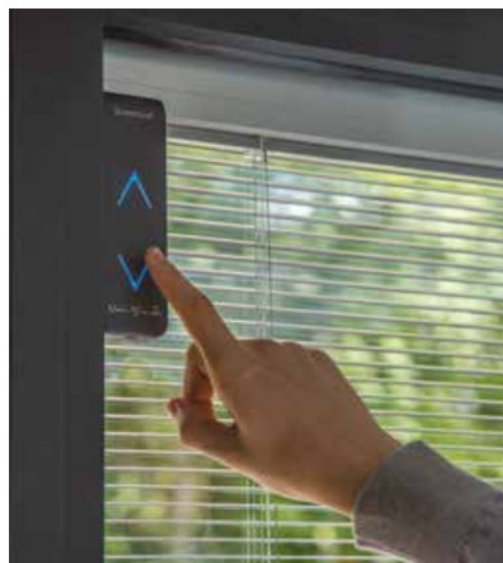

LOW MAINTENANCE

In a busy world our free time is something we cherish. That's why any products that enable us to go about our daily lives without needing to think about maintenance or cleaning are so valuable to us.

Uni-Blinds® with ScreenLine® inside represent the ultimate 'fit and forget' blinds system. As the world's number one integral blinds systems, ScreenLine® blinds are precision engineered to offer long term operational reliability, tested to function beautifully as long as they are needed. This provides total peace of mind that once sealed within the glass and installed, the ScreenLine® blinds will perform for years to come.

With Uni-Blinds®, no cleaning and maintenance is needed. Unlike other window dressings, being sealed between the glass panes, integral blinds are not exposed to the elements, dirty fingers, dust or anything else that can affect their appearance.

The design of the Uni-Blinds® operating mechanism, which mounts onto the frame or glass, depends on which system is chosen. However, none of these require more than occasional light cleaning as part of a normal cleaning routine.







INTRODUCING UNI-BLINDS[®]

Our Blinds

- Sealed for life.
- Guarantee privacy.
- Complete range of systems available.
- Minimal maintenance.
- Nationwide after sales support.
- Industry-leading delivery times.
- Exclusive ScreenLine[®] systems available too.

INTRODUCING UNI-BLINDS®

Unrivalled Uni-Blinds®

Quality Without Compromise

Being permanently sealed within the cavity of the double glazed units makes Uni-Blinds® unrivalled in the control of light and shade, and the only viable option for light control in bi-folding and sliding doors. With ScreenLine® inside, this integral blind system also ensures that you have one of the safest blind systems available.*



Industry's Shortest Lead Times

You don't have to wait an age for Uni-Blinds® either. As the market's number one ScreenLine® systems manufacturer, Morley Glass gives you the shortest lead times, with almost all Uni-Blinds® delivered in just 10/12 working days when ordered on a Friday by 11am.** Check system centre on website for relevant blind model.

**Window blind cords and chains can pose a risk for babies, children and vulnerable people who could injure or even strangle themselves on the hanging looped cords. This potential problem is eliminated by the use of Uni-Blinds®, as the blind is inside the double glazed unit, so effectively away from any misuse or danger. In our corded systems we use an external continuous cord loop that is held permanently against the glass, eliminating any chance of the cord hanging in a loose loop which could be dangerous. This conforms to EN13120 for cord safety.*

***The turnaround time may change due to public holidays.*





A PIONEERING UK MANUFACTURER

Our Place

- Hands on samples and demonstrations models of all blinds.
- See first-hand our manufacturing facility.
- Our staff are specialists in all glass and blind systems.
- Trade customer P.O.S. assets.
- See our quality control systems in operation.





SAINT-GOBAIN

GLASSOLUTIONS



ScreenLine | Integrated blind systems



ABOUT PELLINI

Italian Style and Quality at its Best

Our ScreenLine® range of integral blind systems, which go into every one of our Uni-Blinds® sealed units, is manufactured to the highest quality standards in Italy by Pellini S.p.A. The family owned and run business, founded in 1974, has an unparalleled dedication to craftsmanship and innovation, resulting in technically advanced, high performing products that you can rely on.

ScreenLine® by Pellini S.p.A. is a range of sun shading systems designed and manufactured to be encapsulated within double glazing units, which allow the problems of light and heat gain in buildings to be solved by means of long-lasting, maintenance-free solutions.

The blinds operate in a totally sealed environment, protected from dust, dirt or weather conditions. In doing so, the characteristics of traditional double glazing units are preserved, leaving unaltered the hermetic properties of the cavity. This ensures easy compliance with the requirements of the current Building Regulations for energy performances of buildings.

Within its in-house research and development centre, Pellini S.p.A. has the most knowledgeable and skilled technical teams of their kind, ensuring continuous innovation of ScreenLine® integral blind systems and leadership in the market. Over the past four decades, this has enabled ScreenLine® to achieve a high number of significant patents. These have been applied in a wide range of products designed to meet every sun shading goal – be it colour, screening type, operation method or versatility of application.

That's why Morley Glass and Pellini S.p.A / ScreenLine make the perfect partnership.



CONTROL SYSTEMS

One Concept, Five Control Systems, One Lead Time

- Every Uni-Blind® is manufactured to your requirements
- All Uni-Blinds® systems feature the world's number one integral blind system, ScreenLine®
- Choose a control system to suit your needs
- Pick a colour
- Place your order by 11am Friday and receive it in just 10-12 working days*

* Exclusions apply



SV System: Cordless Slider

The SL16-20V system is a manually operated sliding Venetian or pleated blind featuring a single, cleverly designed magnetic slider to control the whole operation. Positioned on a narrow slide guide on the edge of the sealed unit, the cordless magnetic slider allows the blind to be raised, lowered and tilted effortlessly. Mechanically excellent and functionally reliable over a long service life, this neat blinds system can be used for numerous window and door applications, and for an additional hygienic dimension, the external magnetic slider is treated with the Sanitized® antibacterial finish.

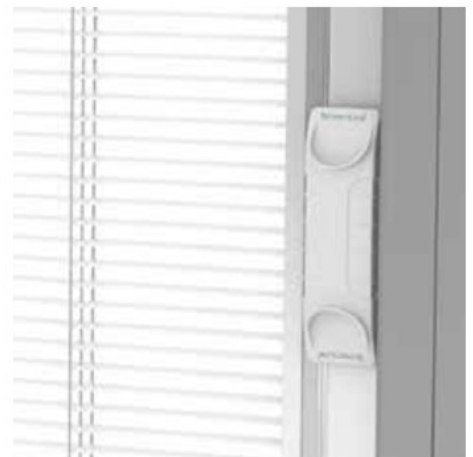



C System: Magnetic Manual Control By Cord, Rotation Knob Or Wand

The SL16-20-22-27C is a classic Venetian blind. It uses a patented magnetic system with manual operation for raising and tilting, incorporated within 16mm, 20mm, 22mm and 27mm cavities. An external magnetic device, applied on the glass to guarantee the integrity of the glass unit, contains a cord loop and a magnet that is perfectly interfaced with the magnetic joint of the internal drive housed inside the head rail. The cord is kept under tension by a special cord tensioner applied to the glass.



S System: Slider

The SL20-22S is a manual system comprising a 14mm pleated blind integrated within a 20mm or 24mm cavities. Movement is achieved by a magnetic device positioned centrally on the outer surface of the internal pane sliding across the glass surface. This external magnet interfaces with a similar internal magnet located in the movable head rail to absorb possible glass deflections, with easy adjustment possible to make it ideal for attic, dormer and skylight applications. And you can choose from 16 exclusive colours only from Morley Glass.



W Smart System: Wire-free Solar Powered

The SL20-22W Smart Uni-Blinds® system is a wire-free, battery operated, motorised blind system. A Venetian or pleated blind is encapsulated within a double glazed unit, which can be raised or lowered via a control device attached to the window or by remote control. The system operates with powerful, long-life rechargeable batteries and is equipped with a cleverly designed external energy-saving solar panel. The system can be fitted quickly and easily to all types of residential and commercial window frames and needs no maintenance.



MB System: Motorised Brushless

Our brushless motor technology in the SL20-22 27MB system is a world away from previous electrical systems used for integral Venetian or pleated blinds. It allows (by means of an encoder) the simultaneous and synchronised operation of several blinds, along with the accurate tilting of the slats. No other control device is applied on glass or window frame – instead, the motor is activated by means of wall-mounted push buttons or an optional remote control. Manufactured from high quality materials, it combines the purity of aesthetic appearance with technical excellence.

ONE CONCEPT, FIVE CONTROL SYSTEMS, ONE ENERGY EFFICIENCY BAR

Superior energy efficiency, built-in

Warm edge spacer bars play a crucial role in double and triple glazed units by insulating the edges as they keep the panes of glass apart. Every Uni-Blinds® unit benefits from this technology, with a custom designed warm edge spacer bar by Technoform, a global leader in specialised plastic solutions.

This is a stainless steel spacer bar which is co-extruded with polypropylene to enhance the benefits of all ScreenLine® integral blinds systems with energy saving qualities – all within the perfect hermetic seal. Its design incorporates locating and guiding elements to improve functional efficiency and ensure no contact is made between the blinds and glass.

- Reduces the generation of humidity on the glass perimeter.
- Improves the thermal insulation of the profile due to its low thermal conductivity.
- Ensures a low Psi value – it halves heat transmission through the perimeter compared to a standard extruded aluminium spacer bar.
- Reduces the thermal transmittance value of the window, irrespective of the material used for the frame.

Uni-Blinds® with ScreenLine® inside is the only integral blind system with a warm edge spacer bar and is available in black as standard or light grey upon request.



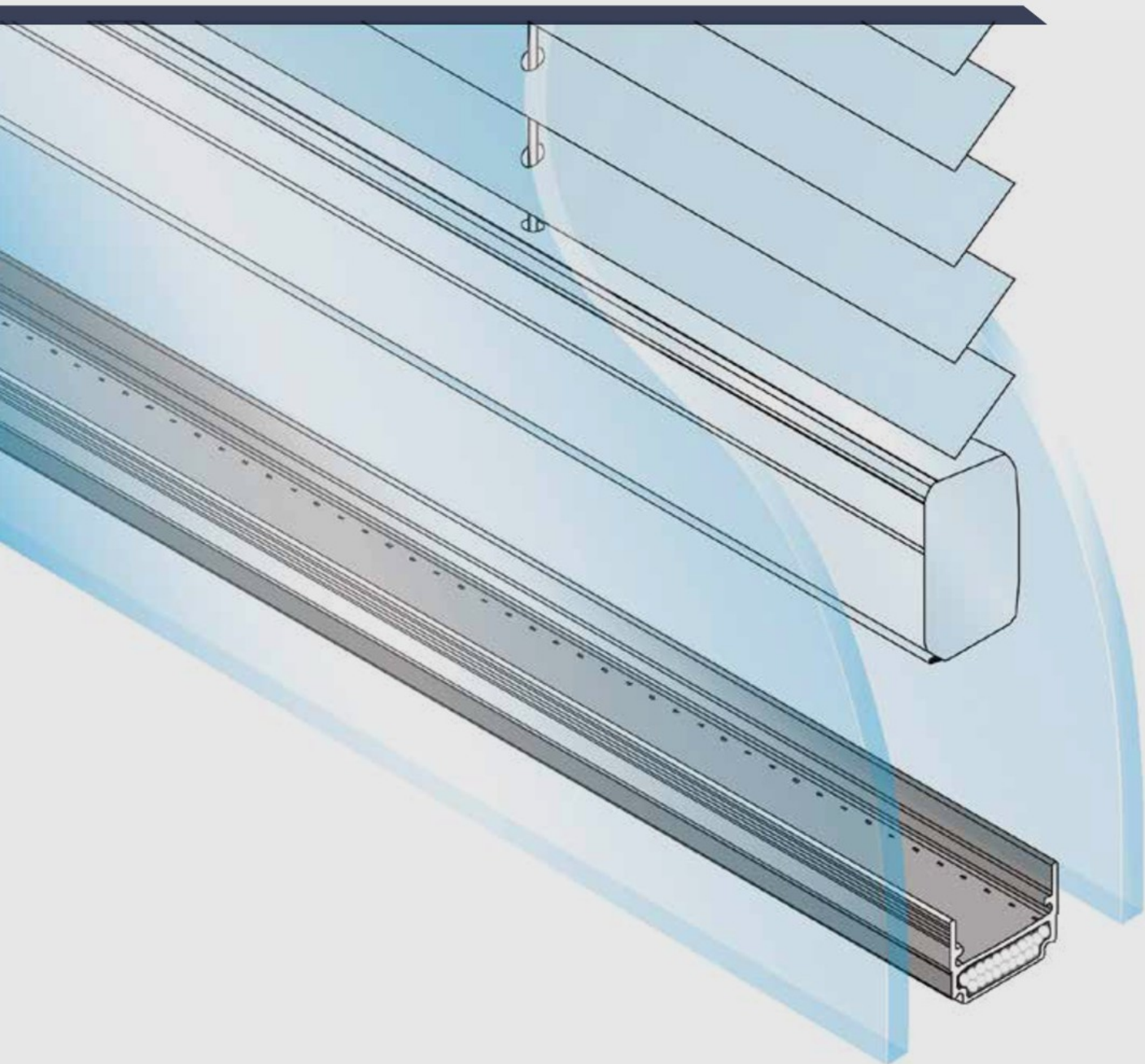



HOW UNI-BLINDS® ARE MADE



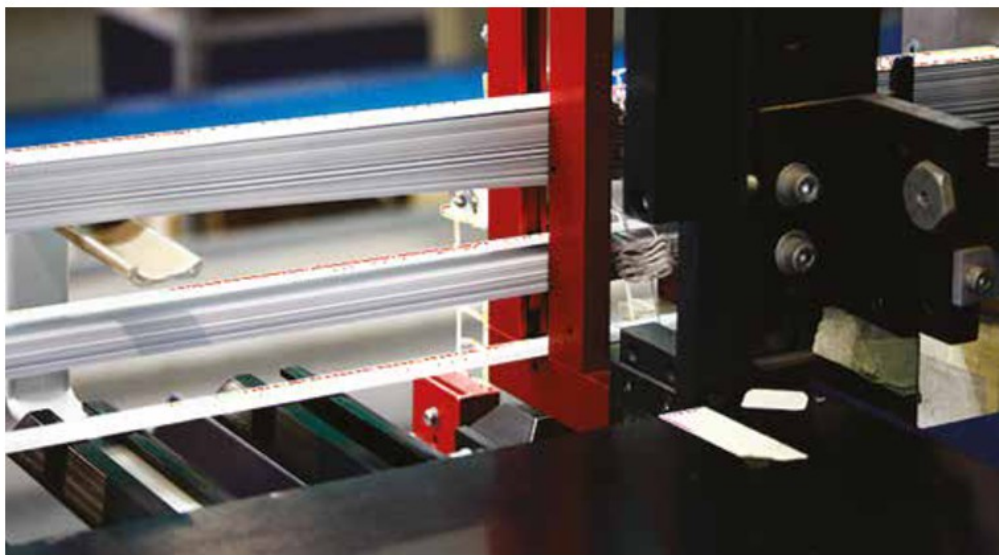
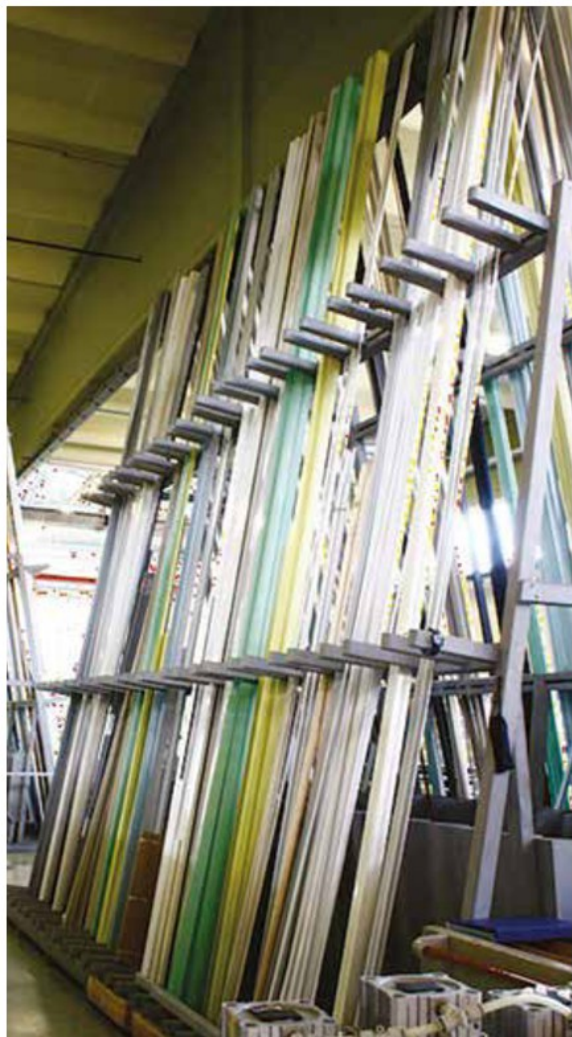
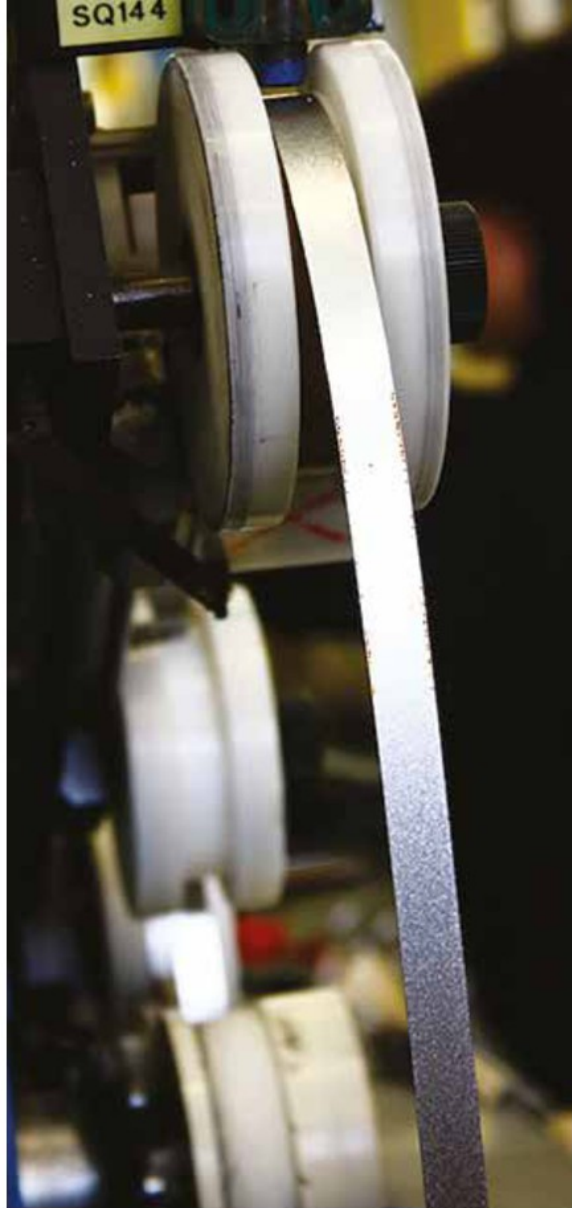

COLOUR YOUR WORLD

Will they match my colour scheme?

Uni-Blinds® come in a range of colours, with Venetian blinds being available in 10 colours and Pleated blinds available in 18 colours to complement your chosen colour scheme.

Swatches available on request.

VENETIAN COLOURS

**S102
WHITE**

Standard

S102 WHITE

Solar reflection 70%
Light reflection 78%
Solar absorption 30%
Standard colour

**S125
BEIGE**

S125 BEIGE

Solar reflection 57%
Light reflection 63%
Solar absorption 43%

**S142
LIGHT BLUE**

S142 LIGHT BLUE

Solar reflection 65%
Light reflection 69%
Solar absorption 35%

**S106
YELLOW**

S106 YELLOW

Solar reflection 62%
Light reflection 72%
Solar absorption 38%

**S130
GREEN**

S130 GREEN

Solar reflection 58%
Light reflection 65%
Solar absorption 42%

**S149
CREAM**

Standard

S149 CREAM

Solar reflection 68%
Light reflection 75%
Solar absorption 32%
Standard colour

**S155
GREY**

S155 GREY

Solar reflection 42%
Light reflection 48%
Solar absorption 59%

**S157
SILVER**

Standard

S157 SILVER

Solar reflection 43%
Light reflection 44%
Solar absorption 57%
Standard colour

**S156
METALLIC
SILVER**

Standard

S156 METALLIC SILVER

Solar reflection 65%
Light reflection 62%
Solar absorption 35%

**S159
ANTHRACITE**

Exclusive

S159 ANTHRACITE

Solar reflection 12%
Light reflection 13%
Solar absorption 88%

**EXCLUSIVE
TO MORLEY
GLASS**

PLEATED COLOURS*

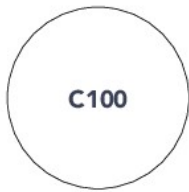

C100 - White
Light reflection 45%
Light transmission 50%
Absorption 5%



C010 - Beige
Light reflection 40%
Light transmission 46%
Absorption 14%



C131* - Sky Blue
Light reflection 16%
Light transmission 13%
Absorption 71%



C145* - Burgundy Red
Light reflection 11%
Light transmission 15%
Absorption 74%



C025* - Pillar Red
Light reflection 12%
Light transmission 17%
Absorption 68%



C331* - Anthracite Grey
Light reflection 14%
Light transmission 9%
Absorption 77%



C235* - Navy Blue
Light reflection 9%
Light transmission 6%
Absorption 85%



C023* - Orange
Light reflection 38%
Light transmission 38%
Absorption 24%



C300* - Coastal Blue
Light reflection 40%
Light transmission 32%
Absorption 28%



C700* - Black
Light reflection 6%
Light transmission 5%
Absorption 89%



C042* - Deep Brown
Light reflection 13%
Light transmission 12%
Absorption 75%





UNI-BLINDS® AT THE FOREFRONT OF BLIND SAFETY

Whichever solar shading approach you are considering for your windows or doors, put safety at the top of your priority list. Accidents involving pull cords on blinds can – and do – happen which is why the British Blind and Shutter Association (BBSA) is working to maximise safety through its 'Make it Safe' campaign.

As would be expected from the UK's largest supplier of integral blinds, all Uni-Blinds® fully conform to the guidelines laid down by the BBSA and none of our products are recommended for installation with free hanging cords. This is a major concern for families with children, in particular.

Safety risks are eliminated using Uni-Blinds® because the external cord mechanism is held securely against the double glazed unit and by using the bottom cord tensioner. A safety break is incorporated into the top external magnetic device. Uni-Blinds® 1600mm high and above are supplied with a standard cord length of 1000mm with other lengths available on request.

Morley Glass is the only UK integral blind manufacturer and supplier affiliated with the BBSA.

Thanks to their patented automatic release system, Uni-Blinds® eliminate the risk from looped blind cords.

What is a tensioner?

The tensioner plays a key safety role. It holds the cord securely against the glass so that it is out of reach from children. You can see how the cord/chain is secured in the image opposite.

SV SYSTEM: CORDLESS SLIDER

SL20SV CORDLESS

SV SYSTEM: CORDLESS SLIDER

The Uni-Blinds® SV System has a magnetic attraction – literally! Offering sliding Venetian or pleated blinds, it features a single, cleverly designed magnetic slider to control the whole operation. Featuring a narrow slide guide on the edge of the sealed unit, a cordless magnetic slider is used to raise, lower and tilt the blind with ease.

SLIDER BENEFITS

- Closed-loop belt transmission system allows smooth and long-lasting function of the blind
- External magnetic slider is treated with the Sanitized® patented antibacterial finish, providing a long-lasting protective function
- Patented warm edge spacer bars and a plastic side profile combine to maximise energy performance of the insulating glass unit
- Fully compliant with child safety standards
- Requires only one device to raise, lower and tilt the slats



Take a look
at the SV System
on our website

Hygiene

Being treated with the world-class Sanitized® patented antibacterial finish, the external magnetic slider benefits from an active biocidal substance containing silver ions for long-lasting protection.

Energy

Perfect for a low energy home, the SV System maximises thermal insulation through its patented warm edge spacer bars and plastic side profile for optimum performance of the insulating glass unit. This delivers the best of both worlds – stylish doors and windows which save energy too.

Patented technology

Innovation goes to the core of the SV System with a patent pending system of internal cord winding on the tube which considerably reduces the blind friction.

Design

Visual appeal is maintained through a neat slider and external guide design which were developed with superior aesthetics at the fore. The result is superb looking doors and windows every time.

Lifespan

Long term peace of mind is provided by the closed-loop belt transmission system, which is designed for smooth and long-lasting function of the blind.

Versatility

You can apply the SV System to all types of door and window frames, even sliding ones, thanks to the slim dimensions of the control device.

User friendly

Operation is simple – just one device is used to raise and tilt the slats.

Safety

- Meets the requirements of child safety standards as recommended by the BBSA
- Protected with Sanitized®
- Active biocidal substance, silver ions
- Hygienic

Key benefits

- Energy saving
- Stylish design
- Patented technology
- Peace of mind
- Fitting versatility
- BBSA Safe
- User friendly

Slide guide and head rail colours



White Beige Grey Anthracite

External slider colour range



White Beige Grey Anthracite

Feasibility chart SL20SV

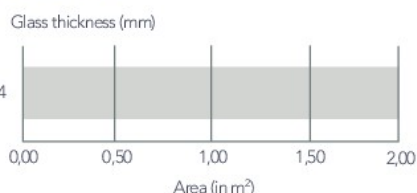

Possible dimensions

W min = 300mm W max = 1500mm
H min = 450mm H max = 2200mm

Maximum height possible according to width

| | |
|-----------------------------|----------------|
| with W = from 300 to 350mm | Max H = 1670mm |
| with W = from 351 to 400mm | Max H = 1800mm |
| with W = from 401 to 1500mm | Max H = 2200mm |

Max. O/A area 2.00mt
Max. height 2.20 high

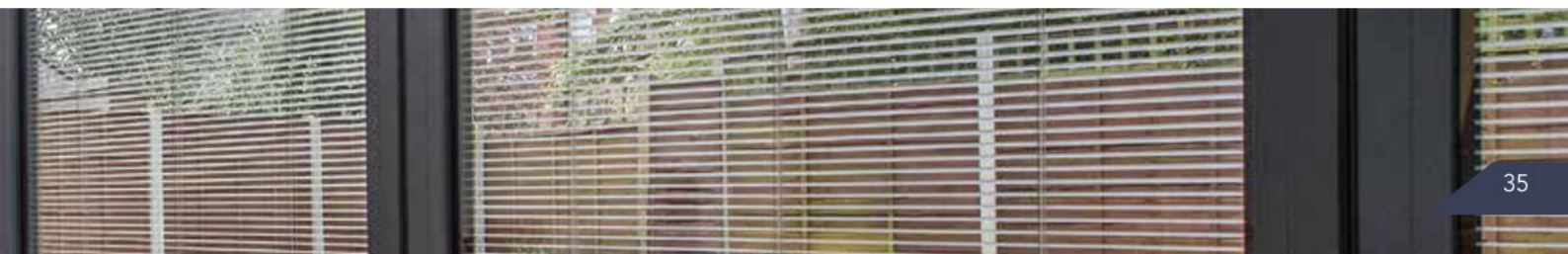



Take a look
at the C System
on our website



Blinds fully open



Blinds partially open

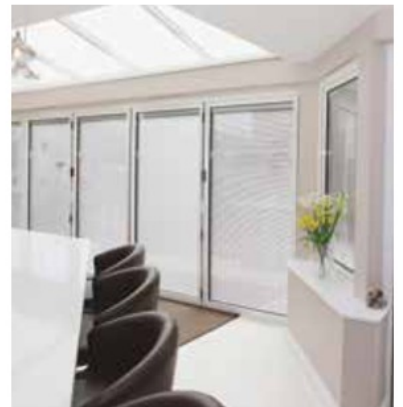

Blinds closed

C SYSTEM MANUAL CONTROL

MANUAL CONTROL FOR LIGHT AND SHADE

Simple, dependable and suitable for many different window and door types, the Uni-Blinds® SL20C system is one of our most popular integral blind systems.

SL20C is manufactured to the highest technical specifications and production standards to guarantee functional and aesthetic excellence that will stand the test of time. The slat raising, lowering and tilting function is achieved using a rotational magnetic transmission through the glass, thereby guaranteeing the unit's hermetic seal.

Key benefits

- Suitable for all vertical window applications
- Ideal solution for conservatory shading
- Total privacy and light control
- Gives excellent utilisation of partitioned office space
- Suitable for retro installation into existing frames
- Only viable option for bi-folding doors

Feasibility chart SL20C

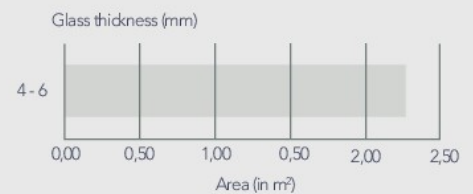

Possible dimensions

W min = 300mm W max = 2000mm
H min = 300mm H max = 2600mm

Maximum height possible according to width

| | |
|-----------------------------|----------------|
| with W = from 300 to 350mm | Max H = 1100mm |
| with W = from 351 to 400mm | Max H = 1800mm |
| with W = from 401 to 450mm | Max H = 2600mm |
| with W = from 451 to 2000mm | Max H = 2600mm |

Over 2.20m² in area P.O.A.

Delivered in as little as 10/12 working days

We are the only UK company able to supply this type of integral blind system within 10/12 working days for an order placed before 11am on a Friday.*

**May alter subject to national and international public/bank holidays.*



Cord system



Rotational knob



Wand

C SYSTEM MANUAL CONTROL

DESIGNED TO MAXIMISE YOUR OPTIONS FOR LIGHT AND SHADE CONTROL

Be in full control of the light in your home

C System blinds operate in several different ways, and the one you choose is really down to personal preference.

Choose how to operate your Uni-Blinds® C System by:

- A rotational cord winder attached at the top of the room-facing pane of the double glazed unit.
- A 'wand', a small pole attached at the top to the room-facing pane of the double glazed unit, which is twisted to open and close the blind.
- An external magnet, fixed to the internal glass by double sided high performance adhesive, which allows for perfect alignment with an internal magnet. Raising and lowering is controlled using a continuous cord loop that drives the external magnet.
- The cord is held lightly under tension by a cord tensioner and fully complies with 'Make it Safe'.







SLIDER CONTROL WITH S PLEATED BLINDS

Great for conservatories

A manual system comprising a 14mm pleated blind integrated within a double glazed unit with a 20mm cavity, the Uni-Blinds® S System is a popular choice for conservatories. Movement of the blind is achieved by sliding a magnetic device positioned centrally on the outer surface of the internal pane across the glass surface.

The external magnet interfaces with a similar internal magnet located in the movable head-rail, designed especially to absorb possible glass deflections.

The S System features Vanity & Verosol pleated blind fabrics*. The latter are coated with an aluminium layer on one side to reduce solar heat gain and improve the whole window U-value, whilst regulating the light passing through.

Light transfer down the blind edge is eliminated by the use of special 'U' shaped warm edge bar.

An extremely versatile product with simplicity of control; the S System integral blind can be adjusted to any position at any inclination from 0° (horizontal) to 90° (vertical). Movement is possible in every dimension; from right to left, from left to right, from the top to the bottom and vice versa.

The S System is also highly modular, with the basic model installed in a 20mm cavity. It's a clever design which makes it possible to install two blinds within the same unit, without compromising the seal integrity.

All this adds up to an ideal solution for the problem of light and heat regulation in garret/attic environments, providing easy and lasting shading within roof windows, whatever their angle.

*For colour options please see page 31.



**Take a look
at the S System
on our website**

S SYSTEM & SV SYSTEM: SLIDER CONTROL

SLIDER CONTROL VENETIAN BLINDS

This SV Venetian blind system is manually-operated using a patented magnetic device to operate the blinds encapsulated within 20mm cavity double glazing units.

A magnetic slider, placed on the right or left-hand edge of the glass, allows the slats to be raised and tilted. The external slider logically moves in the same direction as the blind operating direction. So, the blind is raised and lowered by moving the slider down or up, and tilted by slightly lifting or lowering the same slider.



S Plissé System

The SV System can be used in all types of window frames, even sliding ones, owing to the slim design of the control device. It is also manufactured using a warm edge spacer bar as standard, ensuring that the SV System offers high energy performance and, consequently, saves on heating and air conditioning costs.

Raising



Lowering



Tilting



SP Slider Control Options

W SMART: SOLAR POWERED

WIRE-FREE SOLAR POWERED, ECO-FRIENDLY SIMPLICITY WITH THE W SMART

There is no better demonstration of how Uni-Blinds® can deliver more sustainable homes and commercial buildings than with the W Smart system.

The latest in innovative and ecological Italian design, the W Smart provides you with carbon-saving motorised blinds. A 3.6V motor is powered by a lithium-ion battery charged by an externally mounted solar panel, to deliver a wire-free motorised blind system utilising Venetian or pleated blinds, encapsulated within a 20, 22, 27 or 32mm cavity double glazed unit.

The encapsulated blind is raised, lowered and slat-tilted via the touch button control unit which is magnetically attached to the double glazed unit. This device stores information about each blind, avoiding the need to associate a specific control device for a smarter, easier configuration.

The battery module is designed to achieve the best functionality too. Two LED arrows on the module intuitively show the commands given to the blind and when recharging is needed. The device is discreet too, at only 18mm thick.



Feasibility chart

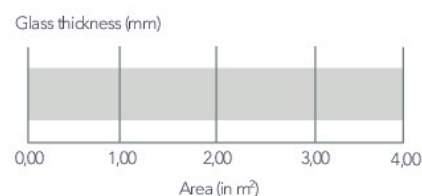

Possible dimensions

W min = 300mm W max = 2000mm
H min = 300mm H max = 2600mm

Maximum height possible according to width Blind with raising and tilting functions

with W = from 300 to 350mm Max H = 1670mm*
with W = from 351 to 400mm Max H = 2020mm*
with W = from 401 to 2000mm Max H = 2600mm**



**Take a look
at the W Smart
on our website**

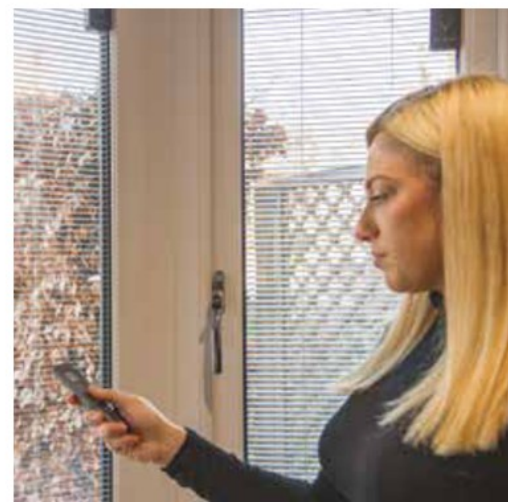
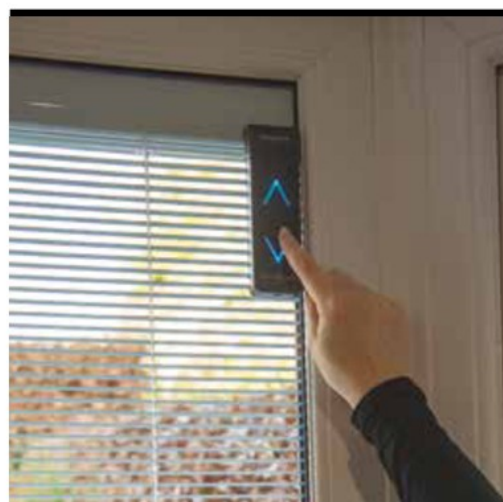
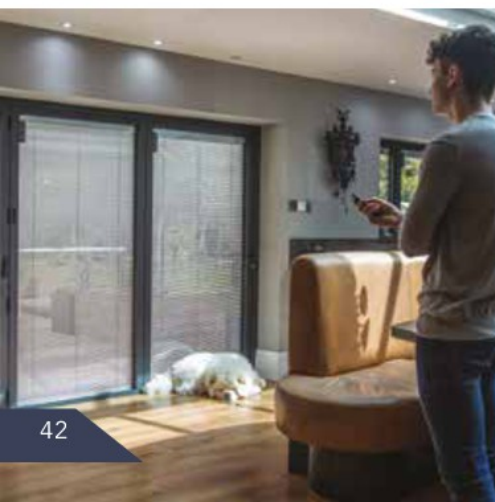

Key benefits

- Streamlined installation procedure
- No need for electrician to install
- No hard-wired power supply required
- Energy saving
- For 20, 22, 27 and 32mm cavity, in Venetian and pleated versions
- Small sized battery module, developed in co-operation with design specialists
- Easy to operate with touch control keys
- Radio remote control receiver as standard
- Battery easy to be replaced by Morley Glass if required



The W Smart is powered and charged via an external solar panel

W Smart's long-life lithium-ion rechargeable battery is contained in a stylishly designed module. And to provide the greatest convenience, a 99-channel remote control option is available too, which links via a radio receiver integrated in the battery module as standard.

As well as private and domestic situations, this system is particularly suited to commercial installations such as medical and educational environments, offices, schools and colleges.



Take a look
at the MB System
on our website

Control at your fingertips

For the discerning homeowner who prefers the speed and synchronicity of an automated home, Uni-Blinds® can also be operated via the flick of a switch or by RF remote control. Talk to us to find out more.



MB SYSTEM: FULLY AUTOMATED

FULLY AUTOMATED PRECISION CONTROL WITH THE MB SYSTEM

Adding convenience and an extra wow factor is easy with the Uni-Blinds® MB System.

Manufactured using premium materials, this technically superior system looks great whilst operating reliably to the highest standard. Using an electric brushless motor, the MB System quietly raises, lowers and tilts the integral blinds safely, smoothly and with precision. This system is ideal for luxury domestic properties and it can be encapsulated within 20, 22 and 27mm cavity double glazed units.

The motorised Venetian or pleated blind has an internal motor integrated within the blind head-rail, incorporating a micro-control unit plus encoder, which allows simultaneous, synchronised movements of groups of blinds.

This technology integrates with a unique control box for motorised blinds developed by Morley Glass, which eliminates installation issues and provides an aesthetically pleasing solution for control at your fingertips. These control boxes are supplied pre-wired and fully tested, making for a smooth problem-free installation, and easy integration with home automation systems.

Manufactured from high quality materials, coupled with the purity of aesthetic appearance and technical excellence, the Uni-Blinds® MB System is perfect for prestigious projects, especially the exclusive contemporary domestic market.

Feasibility chart

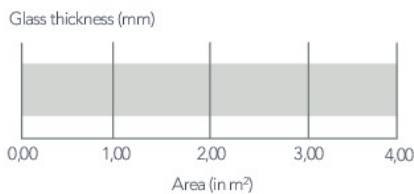

Possible dimensions

W min = 300mm W max = 2000mm
H min = 300mm H max = 2600mm

Maximum height possible according to width

with W = from 300 to 350mm Max H = 1670mm*
with W = from 351 to 400mm Max H = 2020mm*
with W = from 401 to 2000mm Max H = 2600mm**

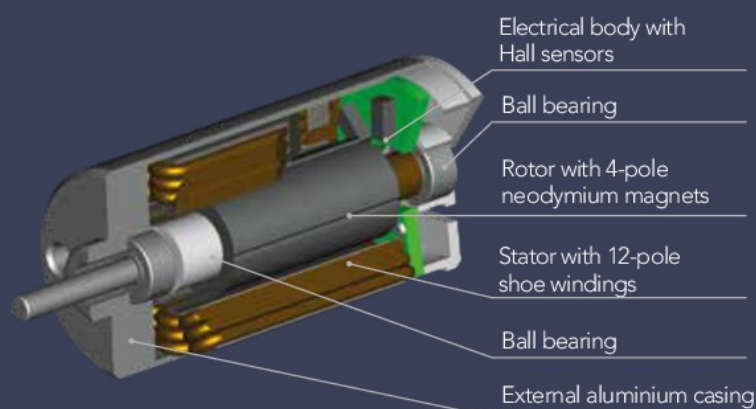

MB SYSTEM: HOME AUTOMATED INTEGRATION

AUTOMATION IS CHILD'S PLAY

Choose a smart solution for Home Automation Integration

Integrating MB System motorised Uni-Blinds® integral blinds into a home automation system is easy thanks to the development by Morley Glass of SmartMotion. This unique interface helps installers quickly and easily incorporate motorised integral blinds in a home automation system to provide homeowners with the ultimate in smart solar shading.

Home automation systems are already widely known for their ability to integrate various domestic applications such as lighting, heating, safety and security, energy management and entertainment systems. Now motorised integral blinds are being added to the mix.

Get SmartMotion

SmartMotion technology is the key. In the past, integration of integral blinds was often a daunting and complex task that could cause damage to the wiring of the blinds or the home automation system itself. This inspired us to invest in a unique interface called SmartMotion, which makes the process so simple it is child's play. In one easy step the operation of the blinds is smoothly integrated into the whole home automation system so that they can be controlled at the touch of a button, even when you're not at home.

Exclusive to Morley Glass, SmartMotion is compatible with the Uni-Blinds® MB System, which operate smoothly and reliably for life thanks to an electric brushless motor. It is supplied pre-wired and fully tested, making for a smooth, hassle-free installation.



Seamless integration with leading automation systems

SmartMotion enables the Uni-Blinds® MB System to be integrated easily with many of the most popular smart home systems, so set-up is a breeze.

Why automate?

Home automation is certainly no fad or gimmick. Just think of the environmental benefits that a combination of smart shading, heating and lighting brings.

Consider the internal temperature within a home. Smart systems ensure that this can be maintained at a comfortable level by automatically turning the heating on or off as required, and using additional 'free' solar gain derived from strong sunshine by raising the integral blinds when possible. These blinds can be automatically closed when too much sunshine causes overheating, preventing a greenhouse effect. All of this helps to maximise energy efficiency by minimising the need for heating or cooling in properties which feature air-conditioning systems.

Light sensors enable lights to be turned on only when natural light is low, and automatic integral blinds can be kept in the open position for as long as possible to maximise light transmission. This helps cut electricity consumption.

The rapid growth of smart homes

Many homes are becoming 'smart' whether we have initiated the technology or not, such as with the roll out of smart meters for gas and electricity. In the next few years, our homes look set to be transformed as technology evolves further.

In 2014, the home automation market globally was worth a sizeable \$4.41bn. Within seven years its value was estimated to be \$45.8bn – in every sense, that's an incredible rate of growth. The Internet of Things (IoT) is driving this change, enabling more and more devices which were once thought of as independent and isolated to be connected via superfast wireless networks. In every sense, that's an incredible rate of growth. The Internet of Things (IoT) is driving this change, enabling more and more devices which were once thought of as independent and isolated to be connected via superfast wireless networks.



Smart motion integration control box

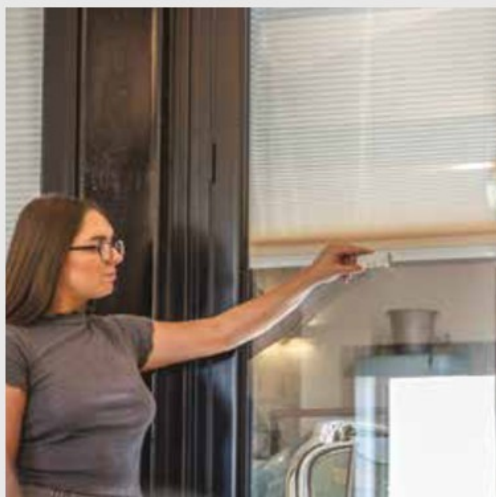



SEAMLESS LOXONE INTEGRATION



MOTORISED UNI-BLINDS® FOR LOXONE SMART HOMES

With the Uni-Blinds® MB System, you have the perfect solution for Loxone home automation. The key is our unique app which allows users to open and close their motorised integral blinds from a tablet or smartphone with ease.

Want to control your blinds from anywhere in the world? No problem. Our fully electronic MB System integrates seamlessly into the Loxone app, enabling blinds to be operated using Wi-Fi connected devices whether you are at home or not. And the app can be installed as part of new MB Systems as well as retrofitting into previous projects.



A revolution in automated blinds

Developed with DV Smarthomes in association with Loxone, we have created a solution that not only offers all the features we know our customers ask for, but a lot more besides. The app allows blinds to be programmed to open and close at set times of the day, especially useful when homeowners are on holiday, and they can even be linked via a subscription service to temperature controls, allowing them to close automatically before rooms get too hot.



Utilising the power of the Loxone Miniserver

The beauty of our app enables Uni-Blinds® MB System blinds to be integrated into the brain of the Loxone home automation system – the Loxone Miniserver. This offers tremendous flexibility and expandability with up to 30 extensions to integrate various domestic applications such as lighting, heating, safety and security, energy management and entertainment systems.



C & S PLISSÉ: PLEATED BLINDS

PLEATED BLINDS: A HIGH PERFORMANCE ALTERNATIVE

Uni-Blinds® integral pleated blinds are the number one choice for homeowners

Our stylish, made-to-measure pleated blinds are manufactured from an exquisite woven polyester fabric in a wide range of colour options to perfectly complement any interior. Enabling a soft diffusion of light, Uni-Blinds® integral pleated blinds are an attractive, elegant blind solution with a number of practical benefits. Not least, with their concertina folds, pleated blinds fold neatly away to provide you with the clearest views – perfect for any window or conservatory.

A double glazing unit with integrated Uni-Blinds® is an excellent screen against solar radiation, allowing you to quickly and easily adjust the internal environmental lighting level. They are an important addition to any home as standard double glazing units will usually not do enough to guarantee correct control of solar energy.

Uni-Blinds® integrated pleated blind systems filter the light with ease, providing a stable internal temperature and maintaining visual comfort by reducing glare whatever the season.



SL20SP Plissé



SL20 Plissé

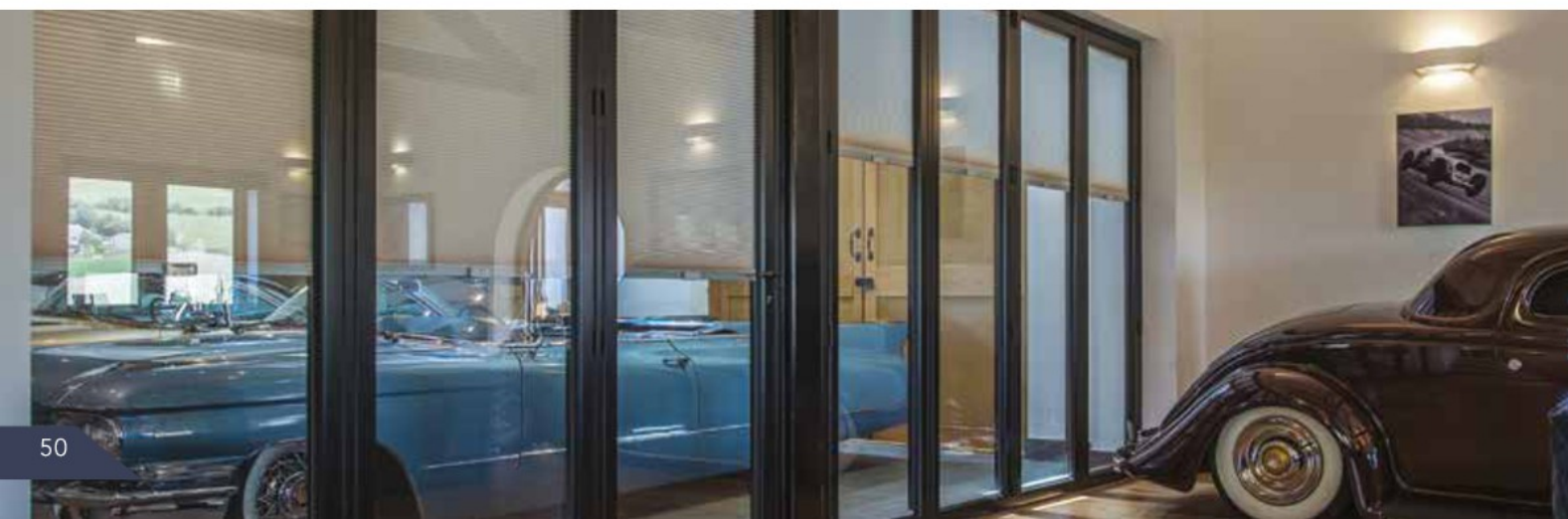

We manufacture and distribute nationwide

Our exclusive contract to manufacture integral pleated SP and S System Uni-Blinds® in the UK, gives us the unprecedented capability to manufacture and distribute nationwide within five working days. Our operatives have been trained by Pellini in Italy to manufacture this market leading product to the exacting standards required.

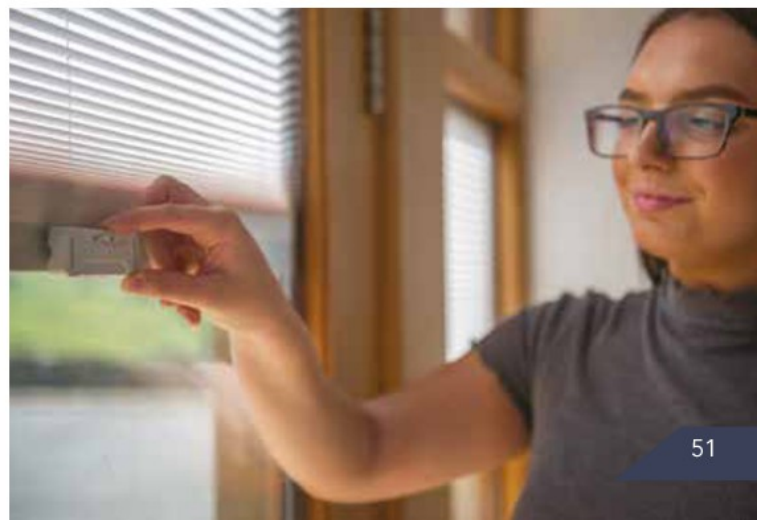

PIONEERING SLIMLINE INTEGRATED BLIND SYSTEMS

UK's first integrated blind system in 16mm cavity

High quality integral blinds are now available for windows and doors which feature a thinner sealed unit thanks to the development of the Uni-Blinds® SL16S and SL16C venetian blinds systems. Providing the perfect solution for composite doors and vertically sliding sash windows in particular, both systems utilise 10mm slats within a 16mm sealed unit to provide slimline Uni-Blinds® options that break new ground in solar shading.

- Exclusive 10mm slats
- Every component expressly designed for a 16mm cavity
- Subtle, elegant appearance for ultimate visual appeal
- IG units with SL16 integrated blind systems can be installed without replacing most existing window frames
- Choice of slider or cord control systems
- Three standard colours available – S102 White, S149 Cream and S157 Silver

“Uni-Blinds® integrated blinds have quickly become the obvious choice for bi-fold and sliding doors thanks to their neat containment which doesn't impair the opening and closing of the doors. Our new slimline SL16S and SL16C systems are repeating this success in vertically sliding sash windows and composite doors which really don't lend themselves to externally mounted blinds.”



Simple, safe and secure

Feasibility chart SL16S & SL16C

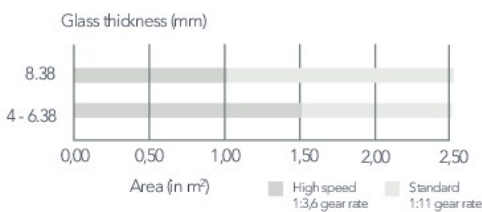

Possible dimensions

W min = 300mm W max = 1200mm
H min = 300mm H max = 2200mm

Maximum height possible according to width

with W = from 300 to 370mm Max H = 1500mm*
with W = from 371 to 1200mm Max H = 2200mm**

* Up to H=2200mm, blind supplied with tilt-only function and locked bottom rail (SL16A)

** For areas from 2.51 m² (2.01m² with 8.38 internal glass thickness) to 2.64 m², blind supplied with tilt-only function and completely raised.

SL16S VENETIAN BLINDS – slider control

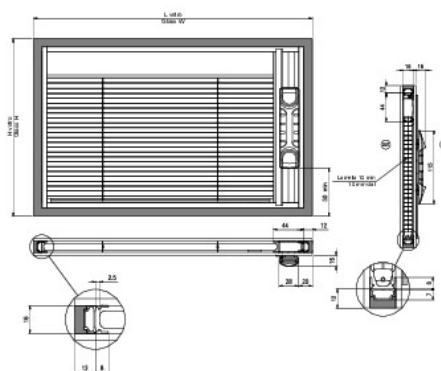

Possible dimensions

W min = 300mm W max = 1200mm
H min = 500mm H max = 2200mm

SL16C VENETIAN BLINDS – exclusive cord control

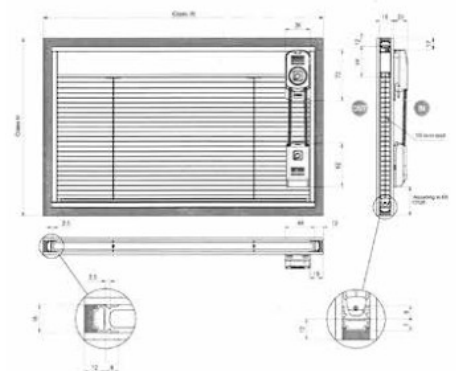

Maximum height possible according to width

with W = from 300 to 370mm Max H = 1000mm
with W = from 371 to 1200mm Max H = 2200mm*

* For areas from 1.61 m² to 2.4m², blind supplied with tilt-only function and completely raised.

SL16S & SL16C SLIMLINE SYSTEMS

SL16S – SLIDER OPERATION

A triumph of the blind movement is achieved by a magnetic device positioned centrally on the outer surface of the internal pane, which slides across the glass surface, used as standard in the SL16S blind range.

SL16C – MAGNETIC OPERATION – EXCLUSIVE TO MORLEY GLASS

SL16C is a patented magnetic system with easy and safe manual movement for lifting and orientation function.

Expertly developed by Pellini S.p.A.

As the only UK manufacturer of ScreenLine® integral blinds, Morley Glass works closely with Pellini's technical team to bring the best solutions to the market. The development of the slimline SL16 systems and integration with our manufacturing capabilities is the perfect example of how we innovate together to deliver class-leading products that open up new possibilities.

A triumph of form and function

SL16 systems combine advanced warm edge spacer bar technology with blinds manufacturing excellence to make a slim integral blinds unit a reality. The Technoform warm edge space bar, used as standard in SL16, is a stainless steel spacer bar co-extruded with polypropylene which ensures the thermal insulation of the sealed unit is maximised for energy saving capabilities.



PLEATED BLACKOUT SYSTEM

For the ultimate privacy and exclusion of external light, there is no better choice than the Uni-Blinds® Pleated Blackout System with ScreenLine® inside.

This system is ideal for any room where even the tiniest amount of light will cause a nuisance or distraction, thanks to a design which leaves absolutely no scope for light transmission. And perfect for slimmer sealed units too, with a 20mm cavity exclusively available.

Why getting a good night's sleep matters

Many people struggle to get a good night's sleep because of light pollution, particularly in busy urban areas. For some, even the smallest amount of light can stand in the way, with streetlights outside a bedroom window and vehicle headlights, in particular, posing a real nuisance.

In fact, a 2016 study by Stanford University found that people living in more urban areas were:

- Exposed to levels of light between three to six times brighter than those in small towns and rural areas
- More likely to be dissatisfied with the quality of their sleep
- Get less sleep in total and more likely to wake up confused during the night, and
- More likely to be fatigued the next day.

That's why it is vital to gain control over the sleeping environment with the Uni-Blinds® Pleated Blackout System. This allows the bedroom to be totally darkened to ease mind and body into a comfortable, uninterrupted sleep mode. It is the perfect solution for light sleepers or shift workers who may need to sleep during the day.

DOMESTIC OPTIONS

- ScreenLine® SL20C
Blackout is operated by a patented magnetic system with manual operation, raising and lowering function
- Side slider operator to provide a sliding function for raising and lowering
- Centre operator – positioned in the centre of the bottom rail to enable raising and lowering function.

COMMERCIAL OPTIONS

- ScreenLine® SL27-29-32C is operated by a patented magnetic system with manual operation, raising and lowering function.
- ScreenLine® SL27-29-32W is a wireless, solar powered motorised system with raising and lowering function.
- ScreenLine® SL27-29-32MB is a fully motorised system with raising and lowering function which can be integrated into home automation systems including Loxone.

Ideal for the children's nursery

Any parent will know how difficult it can be getting young children to sleep at an early bedtime. But in the height of summer when the sun can shine up to 10pm, it is even more difficult for babies and toddlers to understand that bedtime has arrived.

Here the Uni-Blinds® Pleated Blackout System comes into its element. With zero light transmission, a child's bedroom is quickly transformed into the darkest of nights, whatever time of day. In addition, with the pleated blind's material offering excellent thermal insulation, excessive heat in summer evenings is reflected to prevent the nursery becoming too warm.

A great cinema experience at home

The popularity of home cinema rooms is growing all the time thanks to superb high resolution screens and surround sound technology which allow the theatre experience to be replicated for any film buff. But one of the most important factors in achieving the right result is eliminating external light, otherwise it ends up being a distraction and annoyance.

With the Uni-Blinds® Pleated Blackout System, there are no vertical cords running down the blind so no opportunity for light to leak through tiny gaps when in the closed position. Nor are there any gaps around the perimeter. The result is total black-out when the lights are down!

Perfect for protecting assets in public and commercial buildings

The total darkening provided by the Uni-Blinds® Pleated Blackout System on-demand can help protect assets in public and commercial buildings where too much or prolonged light exposure could be damaging. This could include rooms which contain antiques, works of art or where the décor is sensitive to the effects of light, as well as science laboratories or technical research facilities.



Exclusively available in 28mm double glazed units

Depending on your chosen control system, Uni-Blinds® Pleated Blackout blinds are available for 20mm, 27mm, 29mm and 32mm cavities – with the slim 28mm unit option being exclusively manufactured in the UK by Morley Glass. This provides a solution for nearly every type of double glazed window or door whether new build or retrofit.

Innovative spacer bars

The system utilises double-guided spacer bars which are suitably coated in order to reduce reflected light to complete the darkening effect. These are also 'warm edge' to maintain excellent thermal performance in the double glazed unit.





BLINDS SYSTEMS FOR COMMERCIAL AND PUBLIC ENVIRONMENTS

Uni-Blinds® are ideal for numerous new build or retrofit commercial and public sector applications where safety and long term performance are absolutely crucial. Our B System and P System blinds are two systems which offer particular advantages for non-domestic projects, but all our systems can be used whenever the application suits.

Safety is the number one priority whichever Uni-Blinds® system you choose, but the B System and P System offer an additional dimension in that the blind is operated by means of a knob mounted on the window. This is available in an anti-ligature design for sensitive applications.

Specialist technical support is available from Morley Glass at the earliest design stage to ensure your concept is achieved most effectively to the right specification.



**Take a look at the
P System & B System
on our website**



COMMERCIAL & PUBLIC BUILDING SOLUTIONS

B SYSTEM

The Uni-Blinds® B System is a patented manual magnetic blind system manufactured by Morley Glass. The Venetian blinds are encapsulated within a 20 or 22mm cavity with tilt only function.

An external magnetic device is placed on the glass on the lower based rail. Motion is transmitted via two gears located in the top and bottom corner keys of the blind, which are connected to each other by means of a shaft which is completely concealed inside the spacer bar.

The B system is particularly suitable for windowsill applications, such as structural facades, hospital wards and schools as the control device is located at the bottom of the blind, making it readily accessible from a low level or seated position.



P SYSTEM



The P System comprises a Venetian blind incorporating a 12.5mm slat designed to be integrated in a double glazed unit with a 20mm cavity.

The manual tilt only function is operated via a wire drive and an external knob. The specially designed corner key containing the rotational magnet is connected to the external knob by a flexible drive cable located within the glazing cavity of the window frame. Due to the narrow cavity (20mm), the system can be used in almost all types of existing window frames, whilst the special design allows the aesthetic quality to be maintained in whatever environment it is installed. The only visible control is the external anti-ligature knob fixed to the window frame, which is treated with the Sanitized® antibacterial finish, allowing the glass surface to remain completely free and easy to clean.

These particular features make the P System ideal for public environments such as hospitals or government offices where a variety of people need to operate this simple but highly protected system. It can also be modified to incorporate a 16mm slat for integration in a 24mm cavity unit.

FIRE RATED INTEGRAL BLINDS



ASSURED FIRE PROTECTION BUILT-IN

Fire rated Uni-Blinds® with ScreenLine® inside provide crucial protection for people and assets in commercial and public buildings, as well as multiple occupancy residential properties.

- UK's first complete fire rated insulated glass unit with integral blinds inside
- Independently certified for providing either integrity only (E) or radiant heat reduction (EW) fire performance of between 30 and 120 minutes
- Assured protection in sealed units up to 2m² in size
- Choice of manual or motorised control options and available in a wide range of colours

Keeping people and assets safe in the event of a fire is vital, but this need not compromise design and aesthetic ambitions for building interiors. With fire rated Uni-Blinds®, all the advantages of optimised light transmission with privacy and shading on demand can be maintained whilst ensuring passive fire protection is built-in should the worst happen.

Fire rated Uni-Blinds® provide integrity and radiant heat reduction protection of between 30 and 120 minutes depending on the required specification. They comply fully with the performance criteria set out in the EU 305/2011 Construction Products Regulation, and have been independently verified by TUV UK, a UKAS accredited third party testing house.



Technically advanced protection

Morley Glass has always been at the forefront of new window and door technology and nowhere is this more valuable than where safety is concerned. Our fire resistant Uni-Blinds® units combine the benefits of ScreenLine® blinds, manufactured into sealed units which utilise fire glass by Pyroguard.

Pyroguard is one of the UK market leaders in glass for passive fire protection applications. Its UK manufactured glass offers a reliable solution for applications where fire protection is required, with its products ensuring exceptional visual quality and light transmission in combination with UV stability.





GLASS





GLASS QUALITY AND HERITAGE

We've built our reputation on providing the finest quality finished products, key to which is being aligned with the industry's best glass supply chain partner.

All our glass is supplied by GLASSOLUTIONS Saint-Gobain the UK's leading processor and distributor of glass and glass systems. The company has a long heritage of manufacturing glass here in the UK and being part of the global building products company Saint-Gobain, it has a heritage stretching back more than 350 years.

There are few companies in the UK who know more about glass – and do more with it – than GLASSOLUTIONS Saint-Gobain. This ensures Morley Glass and our customers get the best of both worlds – experience, know-how and technical back-up, plus the flexibility and autonomy to best meet the needs of the market.

“Supply Chain Excellence”





GLASSOLUTIONS' parent group Saint-Gobain is present in 68 countries and employs over 170,000 people worldwide, including over 16,500 in the UK and Ireland. It was founded in 1665 to deliver a world first – the production of glass on an industrial scale – and has continued to grow its business via the ongoing development of new services, products and ways of working with customers.

As one of the world's top 100 innovators, Saint-Gobain spends €400m annually on R&D, tackling some of the biggest challenges of our time. Innovation is ceaseless, with one in five products manufactured by Saint-Gobain only invented in the last five years.

In the UK and Ireland, some of the best known and respected companies in the construction sector are part of the Saint-Gobain Group, including British Gypsum, Isover, GLASSOLUTIONS, Saint-Gobain Weber, Saint-Gobain Glass, Saint-Gobain Pam, Pasquill and Ecophon. Together they offer a range of high performance energy-saving products and solutions to help create a more sustainable built environment.

GLASS QUALITY AND HERITAGE



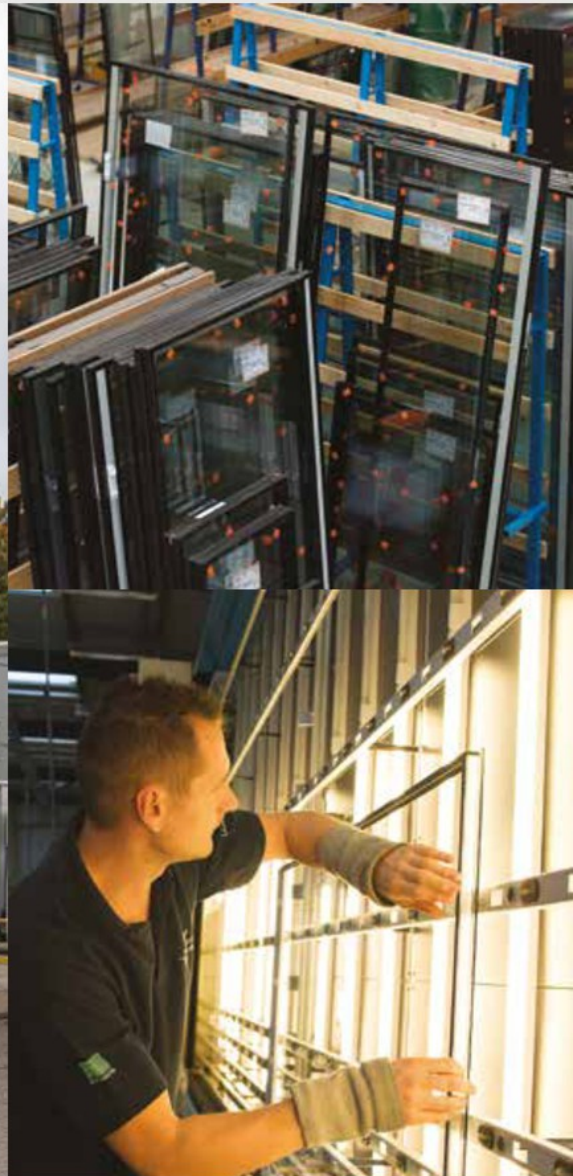

GLAZING INNOVATIONS

Technologically advanced glazing provides year-round comfort, keeping you warm in winter and cool in summer.

All sealed units and Uni-Blinds® from Morley Glass provide the optimum combination of insulation when you need it, while preventing rooms from over-heating in strong sunshine.

We make this possible by using only the UK-made Planitherm series of glass supplied by industry-leading glass processor GLASSOLUTIONS. Planitherm is a family of high-performing low-E glass products with several options to best suit the multi-functional demands on any window, door, conservatory or façade.



GLAZING OPTIONS



Double and triple glazed sealed units are available featuring:

- Planitherm Total+
- Planitherm One
- Planitherm 4S
- COOL-LITE SKN 176 II
- COOL-LITE SKN 183

The Planitherm series is used for all our EcoClear Plus double and triple glazed sealed units to deliver windows and doors with wide ranging aesthetic and comfort benefits. These include:

- Helping to eliminate cold areas around windows, resulting in greater comfort
- Reducing incidence of condensation on the inner pane
- A neutral appearance in both transmission and reflection
- Maximising natural daylight
- Maximising use of living and working areas
- Reducing UV light to dramatically slow the sun's fading effect on furniture and furnishings

All our sealed units are manufactured by combining Planitherm with either Planiclear or Diamant products from Saint-Gobain Glass.

In addition to Planitherm, we offer Saint-Gobain's enhanced solar control glass products, COOL-LITE SKN 176 II and SKN 183. The exact SKN specification of your sealed unit will depend on the application, not least the size and orientation of the window or door. For the best result, just talk to us and we will provide all the support you need to achieve the best result.

PLANITHERM TOTAL+

Achieve the perfect balance with Europe's leading low-E glass.

The difference is clear with Planitherm Total+. This high quality glass combines excellent thermal performance with the ultimate in clarity thanks to a virtually invisible, microscopically thin coating.

Planitherm Total+ sealed units are the ideal solution for general fenestration requirements given their compatibility for windows and doors which are 'A' rated under the Window Energy Ratings (WERs) scheme.

With its advanced qualities from a trusted glass manufacturer, it is no surprise that Planitherm Total+ is one of the most widely used and best performing energy efficient window glass products available today.

Enhanced thermal insulation

Double glazed units incorporating Planitherm Total+ offer up to three times more insulation than standard double glazing, and significantly better thermal insulation compared to hard coated low-E products. This will deliver considerable savings on heating bills and eliminate cold areas around windows.

More comfortable, healthier homes

Planitherm Total+ also maximises the amount of natural light into the home, without haze or tint effects, and it helps to reduce condensation on the inner pane.

Sustainable and fully compliant

With its superb insulation qualities, Planitherm Total+ is an environmentally sustainable choice. By keeping more warmth inside the home, energy usage and, hence, CO2 emissions can be reduced. These sealed units are also fully compliant with current Building Regulations requirements for all frame types or designs, and exceptional Window Energy Rating (WER) performance is achieved thanks to the optimised balance between a very low U-value and even higher solar gain.

QUICK FACTS

- Market-leading low-E glass
- Ideal for general fenestration requirements
- Maximises natural daylight and delivers comfortable homes



Read more about
Planitherm Total +
on our website

BOOST YOUR NATURAL LIGHT

Planitherm has the best light transmission properties compared to all competitor products.

No unsightly tint or 'haze' effect – unlike traditional low-E coatings that suffer from an unsightly yellow tint, Planitherm Total+ looks very clear. This delivers great looking windows as curtains or Georgian Bars will not look dirty or discoloured.

More light – reduced tint also means more light can enter the room, making it feel more natural, comfortable and luminous.



Technical specifications

| Performance Data | DGU | | TGU | |
|---------------------------------------|-----------------------|-------------|-----------------|-------------|
| Internal Pane | SGG PLANITHERM TOTAL+ | | | |
| External Pane | SGG PLANICLEAR | SGG DIAMANT | SGG PLAINICLEAR | SGG DIAMANT |
| Composition in mm | 4(16)4 | | 4(16)4(16)4 | |
| Low-Emissivity Coating Position | Face 3 | | Face 3/5 | |
| Light Transmission | 81% | | 72% | 73% |
| Light Reflectance | 12% | | 16% | |
| LRi | 13% | | 16% | |
| T | 64% | 66% | 52% | 53% |
| RE | 20% | 21% | 25% | 26% |
| A1 | 6% | 3% | 6% | 3% |
| A2 | 9% | 10% | 11% | 11% |
| A3 | - | - | 6% | 7% |
| g-value | 0.73 | 0.75 | 0.63 | 0.64 |
| Shading Coefficient | 0.83 | 0.86 | 0.72 | 0.74 |
| U-value in W/m ² K** - Air | 1.4 | | 0.8 | |
| 90% Argon | 1.2 | | 0.6 | |

SGG PLANITHERM TOTAL+ meets the durability requirements of class C or European standards EN 1096 and is marked.

* Light and solar performance according to EN 410.

** Centre-pane U-values have been rounded in accordance with EN 673.

For Window Energy Ratings simulators should calculate whole window U-values from first principals using normal surface emissivity ($\epsilon = 0.05$).

PLANITHERM ONE

Enhanced thermal insulation

- An optimum centre-pane U-value of 1.0W/m²K (16mm, 90% argon-filled cavity), comfortably meeting current Building Regulations requirements for the whole window U-value for all frame types.
- Ideal for residential new build, plus light commercial new build and renovation projects using steel or aluminium frames.
- Scope for considerable reductions in heating requirements versus standard glass.
- Environmentally friendly solution, given the lower CO₂ emissions associated with reduced energy consumption.



Read more about
Planitherm One
on our website

Technical specifications

| Performance Data | DGU | | TGU |
|---------------------------------------|----------------------|--------|----------------------|
| Internal Pane | SGG PLANITHERM ONE T | | SGG PLANITHERM ONE T |
| External Pane | SGG PLANICLEAR | | SGG PLANICLEAR |
| Composition in mm | 4(16)4 | 6(16)6 | 4(16)4(16)4 |
| Coating Position | Face 3 | | Face 3/5 |
| Light Transmission | 70% | 69% | 55% |
| Light Reflectance | 21% | 21% | 30% |
| LRi | 23% | 23% | 32% |
| g-value | 0.55 | 0.54 | 0.42 |
| Shading Coefficient | 0.63 | 0.62 | 0.49 |
| U-value in W/m ² K** - Air | 1.3 | 1.3 | 0.7 |
| 90% Argon | 1.0 | 1.0 | 0.5 |

SGG PLANITHERM ONE meets the durability requirements of class C or European standards EN 1096. Light and solar performance are in according with EN 410.

* Positioning the coating on Face 2 reduces the g-value in DGU to 0.49 (4mm) and 0.48 (6mm).

Superior performance 'single-stock' low-E glass with an optimum centre-pane U-value of 1.0 W/m²K

Designed specifically to minimise heat loss, Planitherm One is ideal for achieving the lowest U-values. The advanced coating of Planitherm One offers insulating levels far in excess of the minimum requirements set out in Approved Document L of the Building Regulations.

Its excellent performance capability is in the name – a double glazed sealed unit featuring Planitherm One will deliver an optimum centre-pane U-value of 1.0W/m²K (16mm, 90% argon-filled cavity).

If higher thermal insulation levels are your goal, Planitherm One represents the perfect choice. It is the most advanced thermal insulation performance within the Planitherm family, Europe's best selling low-emissivity (low-E) glass and one of the UK's leading offline low-E coating brands.

Comfort and aesthetics

- Helps to eliminate cold areas around windows resulting in greater comfort
- Reduces incidence of condensation on the inner pane
- Neutral appearance in both transmission and reflection
- Maximises entry of natural daylight
- Maximises use of living and working areas.

QUICK FACTS

- Perfect for achieving the lowest U-values
- The Planitherm choice for maximum energy efficiency
- Neutral appearance for superb visual appeal



PLANITHERM 4S



Transform a conservatory into a space that's comfortable all year round.

There is no better glazing solution for conservatory side walls than Planitherm 4S. This special option in the market-leading Planitherm family from Saint-Gobain offers a high level of thermal insulation in colder months, whilst being able to manage the risk of excess heat gain even in the strongest, direct summertime sunshine.

That's why we call it "4 Seasons" – whatever time of year, Planitherm 4S has the right blend of multifunctionality to provide an effective solution.

Planitherm 4S is designed for use in double glazed units in all frame types for both residential new-build and replacement markets, ideally for:

- Windows and skylights in residential buildings and private domestic housing
- Conservatories and patio doors.

Why choose Planitherm 4S?

- Thermal insulation: reduces heat loss more effectively than traditional low-E products
- Solar protection: reflects up to 56% of solar heat gain through conservatory sidewalls and as much as 79% when used in conjunction with Bioclean Aqua in the roof areas
- Energy efficient: energy consumption for a conservatory can be reduced by as much as 28%, meaning that Planitherm 4S can deliver homes with lower CO2 emissions that cost far less to run
- Visual comfort: maximum natural light and reduced glare enhances how the conservatory or room looks
- Neutral appearance: beautiful neutral appearance provides consistency with the glazing in the rest of the property

QUICK FACTS

- No better choice for conservatory side wall glazing
- Dual purpose insulation for winter warmth and summer cooling
- Up to 79% solar reflection when used in conjunction with Bioclean Aqua roof glazing

ALL YEAR ROUND **BENEFITS**

Use Planitherm 4S in a conservatory and experience some remarkable benefits:

STAY COOL IN SUMMER

For ROOFS when combined with special dual-coated self-cleaning and solar control glass

- Heat reflection 71%
- Glare Reduction

If used alone in SIDEWALL double glazing

- Heat reflection 57%
- Attractive neutral appearance

KEEP WARM IN WINTER

For ROOFS when combined with special dual-coated self-cleaning and solar control glass

- Less heat loss compared to ordinary double glazing 63%
- Reduced condensation
- Save pounds on your heating bills
- Cold spots and drafts reduced
- Unbeatable thermal-insulating U-value of 1.0 W/m²K

Technical specifications

| Application | Inner pane | Outer pane | Heat reflection | Glare reduction | U-values | Reduced condensation | Naturally self-cleaning |
|-------------|-----------------|---------------|-----------------|-----------------|--------------------------|----------------------|-------------------------|
| Roofs | Bioclean AQUA | Planitherm 4S | 78% | 68% | 1.0 (W/m ² k) | ✓ | ✓ |
| Roofs | Bioclean NATURA | Planitherm 4S | 71% | 63% | 1.0 (W/m ² k) | ✓ | ✓ |
| Roofs | Bioclean AZURA | Planitherm 4S | 67% | 53% | 1.0 (W/m ² k) | ✓ | ✓ |
| Roofs | Bioclean SOLARA | Planitherm 4S | 66% | 58% | 1.0 (W/m ² k) | ✓ | ✓ |
| Roofs | Planitherm 4S | Float glass | 57% | 35% | 1.0 (W/m ² k) | ✓ | |



Your glass. Our world.



Read more about
Planitherm 4S
on our website

COOL-LITE SKN 176 II



NEUTRAL APPEARANCE

The special microscopic coating applied to COOL-LITE SKN 176 II allows for clarity and neutrality, with no unwelcome tint which can detract from a building's looks. It is designed to optimise light transmittance too, reduces the requirement for interior lighting during daylight hours – this helps reduce energy costs and CO2 emissions even further.

APPLICATIONS

COOL-LITE SKN 176 II is for use in residential or commercial buildings, either for façades or overhead glazing. The 4mm option is perfect for use in high end residential and low end commercial applications, providing extended functionality and design flexibility whilst retaining excellent neutral aesthetics.

Technical specifications

| Performance Data | DGU with SGG COOL-LITE SKN 176 II |
|-----------------------------------|-----------------------------------|
| Internal Pane | SGG PLANICLEAR |
| External Pane | SGG COOL-LITE SKN 176 II |
| Composition in mm | 6(16)6 |
| Coating Position | Face 2 |
| Light Transmission | 70% |
| Light Reflectance | 13% |
| LRi | 15% |
| g-value* | 0.37 |
| Shading Coefficient | 0.43 |
| U-value in W/m ² K Air | 1.3 |
| 90% Argon | 1.0 |

SGG COOL-LITE SKN 176 II meets the durability requirements of class C or European standards EN 1096-1 and -2.
* Light and solar performance according to EN 410.



Read more about
COOL-LITE SKN 176 II
on our website



Deliver outstanding solar control with excellent neutrality in high end residential or commercial projects

Combining high performance solar control with excellent neutrality, COOL-LITE SKN 176 II is ideal for applications requiring high light transmittance combined with a low g-value.

COOL-LITE SKN 176 II features a high performance coating, which is applied to Planiclear float glass by cathodic sputtering under vacuum conditions. This coating is designed to enable solar gain to be managed, in order to prevent overheating inside individual rooms on sunny days, whilst providing excellent thermal insulation in colder periods. All this without affecting the sealed unit's neutrality!

Such is the effectiveness of this coating, that double glazed units manufactured with COOL-LITE SKN 176 II offer:

- High light transmission 70%
- Low g-value of 0.37
- Excellent U-Value of 1.0W/m²K
- The highest degree of neutrality

ACTIVE, SUSTAINABLE SOLAR SHADING

COOL-LITE SKN 176 II helps to create more comfortable interiors by reducing overheating and the need for costly air conditioning. This enables property owners to reduce energy consumption and, hence, their CO₂ emissions, with the glazing playing an active role in managing energy usage throughout the duration of the building's lifespan.

The level of solar control provided by COOL-LITE SKN 176 II means that buildings can even be designed without external solar shading devices. This can allow a different approach to building design and aesthetics.

QUICK FACTS

- Proven high performance solar control glass, used extensively across Europe
- Creates sustainable homes and buildings by reducing the need for air conditioning
- Excellent neutrality with high light transmission of 70%

COOL-LITE SKN 183



For next generation performance with the best ever level of glass neutrality, Morley Glass offers the highly advanced COOL-LITE SKN 183 from Saint-Gobain.

COOL-LITE SKN 183 is the latest addition to our glass portfolio, ensuring you have access to the most innovative types of solar control glass on the market. Ideal for façade glazing, such as curtain walls, window band facades and punctuated facades, the glass stands out for its clarity and low reflection, enabling natural light to fill a room or building without the risk of overheating on sunny days.

THE CLEAREST CHOICE

Commercial, public and residential buildings can all benefit from COOL-LITE SKN 183, particularly those where high daylight income is desired to achieve a bright interior atmosphere, with no compromise on performance. Typical of the applications suited to this type of glass are:

- Educational facilities where daylight helps students focusing and learning
- Hospitals where daylight is a healing factor and source of well-being
- Mixed-use projects (commercial and residential applications in the same building) where the window/wall ratio is often smaller, thus limiting the amount of daylight coming through the façade.

COOL-LITE SKN 183 delivers its outstanding selectivity thanks to a highly advanced double-silver coating which is applied to the glass by Saint-Gobain Glass. This is the key to providing the best of both worlds, enabling a neutral appearance and 75% light transmission without compromise.

COOLING EFFECT FOR ZERO-CARBON BUILDINGS

In addition to excellent light transmission, COOL-LITE SKN 183 provides very effective solar protection with a solar factor of 0.40 in double glazed units (DGUs). This enables façade design that can help meet top-class energy performance objectives while maintaining a cool, comfortable internal environment for occupants. This reduces the requirement for energy-consuming air-conditioning, hence making COOL-LITE SKN 183 ideal for clients who are seeking to create the greenest buildings.



**Read more about
COOL-LITE SKN 183
on our website**

QUICK FACTS

- A market leading light transmission level of 75% (TL).
- Low solar factor (40%), high selectivity ($S = 1.88$) and neutral aesthetics.
- Proven carbon-saving solar control performance making it ideal for high-end residential and low energy commercial buildings.

SUPERIOR THERMAL PERFORMANCE

The advanced coating developed for COOL-LITE SKN 183 also enables clients to reduce their energy consumption in winter months. The dual-action of reflecting excessive heat from the sun and providing excellent thermal insulation when external temperatures drop, keeps a building's climate stable and comfortable. Heating loads are reduced in winter as a result of the product's excellent thermal insulation levels with a Ug value of 1.0 W/m²K.

TECHNICAL SPECIFICATIONS

| Performance Data | COOL-LITE SKN 183 & SKN 183 II |
|-------------------------------|--------------------------------|
| Internal Pane | PLANICLEAR |
| External Pane | COOL-LITE SKN 183 & SKN 183 II |
| Composition in mm | 6(16)4 |
| Coating Positions | Face 2 |
| LT | 75% |
| LRe | 12% |
| LRi | 13% |
| g-value* | 0.40 |
| U-Value in W/m ² K | 1.0 |
| Air | 1.0 |

COOL-LITE SKN 183 & 183 II meets the durability requirements of class C of European standards EN 1096-1 and -2.

LUMINOUS FACTORS

| | |
|----------------------------|--------|
| Light transmission (TL %) | 74.6 % |
| Outdoor reflection (RLe %) | 12.0 % |
| Indoor (RLi %) | 13.0 % |

SOLAR FACTORS

| | |
|--------------------------|--------|
| Solar factor (g) | 0.3996 |
| Shading Coefficient (SC) | 0.4594 |

COLOUR RENDERING

| | |
|-------------------|------|
| Transmission (Ra) | 95.8 |
| Reflection (Ra) | 84.7 |

ENERGY FACTORS

| | |
|-------------------|--------|
| Transmission (Te) | 38.0 % |
| Reflection (Ree) | 33.8 % |
| Indoor (Rei) | 38.4 % |
| Absorption (AE1) | 27.3 % |
| Absorption (AE2) | 1.0 % |

THERMAL TRANSMISSION

| | |
|----|---------------------------|
| Ug | 1.040 W/m ² .K |
|----|---------------------------|

0° related to vertical position

MANUFACTURING SIZES

| | |
|-------------------|------------------------|
| Nominal thickness | 26.0 mm |
| Weight | 25.0 kg/m ² |

ACOUSTICS

| | |
|--|--------------------------|
| Acoustic values according to EN 12758 and from notified body | Rw(C;Ctr) = 35(-1;-5) dB |
|--|--------------------------|

CIE (15-2004)

74.6 %

12.0 %

13.0 %

EN410 (2011-04)

0.3996

0.4594

CIE (15-2004)

95.8

84.7

EN410 (2011-04)

38.0 %

33.8 %

38.4 %

27.3 %

1.0 %

EN673 (2011-04)

1.040 W/m².K

26.0 mm

25.0 kg/m²

EN12758

Rw(C;Ctr) = 35(-1;-5) dB



CONSERVATORY GLASS



Your glass. Our world.

CONSERVATORY GLASS

Deliver the perfect conservatory with our outstanding glass range from Saint-Gobain.

The choice of glass for the roof and sidewalls has a major impact on the overall feel and comfort of a conservatory, so it is vital to consider the options.

Whether it is a new conservatory, a refurbishment or upgrade, today's advanced glass options will enable you to deliver a fantastic space every time. Whether the conservatory is primarily to add extra relaxation space that can be used year round, a dining room, a children's playroom, home office or similar, the glazing specification will need to take into account thermal, light transmission and solar gain factors.

Morley Glass offers the Bioclean range and Planitherm 4S from Saint-Gobain Glass to give you the flexibility to accommodate any conservatory requirement.



HEAT REFLECTION

Measured by taking the opposite or inverse of the glazing solar factor. Solar factor is the percentage of the total solar radiant heat energy entering the room through the glass. Bioclean reflects up to 78% of the sun's heat, keeping the conservatory up to 9°C cooler in the summer.



THERMAL INSULATION

A measure of the rate of heat loss through the glazing. A principle reason for installing energy efficient glass, the lower the U-value the better the glass is at retaining heat. Bioclean is 63% better insulating than standard glass, keeping the conservatory warmer in winter and saving money on heating bills.

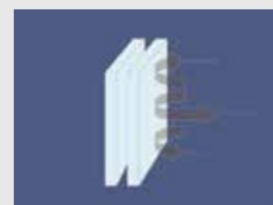

SELF-CLEANING GLASS

Why not integrate self-cleaning glass? This features a coating that is fully integrated into the surface of the glass ensuring its permanency. In a process called 'catalysis' the coating uses UV rays from the sun to break down organic dirt and turns the surface hydrophilic. Rain or hose pipe water then forms a sheet of water and rinses the dirt away, reducing the need for manual cleaning. Also prevents water droplets from forming which means clear views, even when it's raining.



GLARE REDUCTION

Measured by the inverse of 'light transmission', the proportion of the visible light spectrum that is transmitted through the glass. It is important to reduce the transmission of concentrated light, especially in the roof, to maximise visual comfort. Bioclean reduces up to 68% of the sun's glare, maximising visual comfort on the brightest of days. Like sunglasses for the roof!



VIRTUAL ELIMINATION OF CONDENSATION

Internal condensation will only begin to form at an average external temperature of -11°C (in timber/PVCu frames at an internal temperature of 20°C and 50% relative humidity). Bioclean is designed to prevent this.



Making the right choice

Choosing the right glass is perhaps one of the most important decisions in a conservatory design and build, but it needn't be a tough one. Take a look at the following comparison chart, designed to help you choose the perfect combination of Saint-Gobain Glass products exactly match your specific criteria.

| Application | Inner pane | Outer pane | Heat reflection | Glare reduction | U-values | Reduced condensation | Naturally self-cleaning |
|-------------|-----------------|---------------|-----------------|-----------------|-------------|----------------------|-------------------------|
| Roofs | Bioclean AQUA | Planitherm 4S | 78% | 68% | 1.0 (W/m²k) | ✓ | ✓ |
| Roofs | Bioclean NATURA | Planitherm 4S | 71% | 63% | 1.0 (W/m²k) | ✓ | ✓ |
| Roofs | Bioclean AZURA | Planitherm 4S | 67% | 53% | 1.0 (W/m²k) | ✓ | ✓ |
| Roofs | Bioclean SOLARA | Planitherm 4S | 66% | 58% | 1.0 (W/m²k) | ✓ | ✓ |
| Roofs | Planitherm 4S | Float glass | 57% | 35% | 1.0 (W/m²k) | ✓ | |

BIOCLEAN SELF-CLEANING CONSERVATORY ROOF GLASS

Enjoy the view without the hassle of cleaning a conservatory roof

Our Bioclean self-cleaning glass option is the perfect way to make use of technology to cut down on maintenance and cleaning hassles.

This revolutionary self-cleaning coating is applied to the glass as part of the manufacturing process, meaning that it is fused to the surface of the glass. This ensures Bioclean lasts the lifetime of the pane.

The special Bioclean coating uses both rain and natural light from the sun to efficiently combat the dirt and grime that accumulates on the outside of the window. By significantly reducing the need for manual cleaning, it provides the ideal solution for keeping those hard or dangerous to reach areas clean, leaving householders with more time to relax and enjoy the view.

Tint options

Bioclean is available in a choice of four tint options to match your precise specification requirements and deliver the perfect solution every time.

How Bioclean self-cleaning glass works

There are several processes at work:

- The special coating harnesses natural daylight which triggers the breakdown of the dirt and grime on the outer surface of the glass.
- When rainwater hits the glass, rather than forming droplets it flattens and spreads out across the surface of the glass helping to wash away the loosened dirt and grime.
- This sheeting effect also minimises spots and streaks by helping the glass to dry more quickly and evenly.



CONSERVATORY GLASS

Self-cleaning glass advantages

- The permanent self-cleaning coating lasts the lifetime of the window
- Perfect for conservatory roofs and other hard to reach areas
- Glass stays cleaner for longer
- Less dirt and grime adheres to the glass, so any cleaning is quick and easy
- Ongoing cost savings with reduced window cleaning bills
- Kinder to the environment with a less frequent use of water and detergents
- Clear view outside even when it's raining thanks to the sheeting effect



AQUA

A pleasant, relaxing aqua green appearance to complement interiors and surrounding natural garden tones.



NATURA

A virtually neutral glass to complement existing glazing.



AZURA

An attractive blue tint.



SOLARA

A bronze tint which is ideal for timber and dark conservatory frames.

SELF-CLEANING GLASS

NON-STICK GLAZING THROUGHOUT THE HOME

Reduce window cleaning requirements with ClearShield protection

We offer a superb solution for all windows and doors which takes away the hassle of frequent cleaning and keeps them looking good as new for longer.

All our sealed units are available with Ritec's award-winning ClearShield System. This has been specially developed for the protection, renovation and maintenance of both new and already installed glass.

Just like a non-stick frying pan, ClearShield provides a protective barrier for the surface of glass that is much more effective than a coating. It cuts the amount of window cleaning needed by up to 70% without affecting the transparency or solar gain (g-value) of the glass.

ClearShield protected glass:

- Is always easier to clean and keep clean
- Stays cleaner for longer
- Resists staining and discolouration.

Remember, the benefits of ClearShield protection are not restricted to new sealed units – we can upgrade existing windows too.

Factory or on-site application

Morley Glass is approved and fully trained by Ritec to apply ClearShield. It is applied to glass on site for glass already installed or in the factory onto new glass.



NORMAL GLASS



SELF-CLEAN GLASS







BACKPAINTED GLASS

The must-have kitchen and bathroom feature

High quality backpainted glass adds that special appeal to any contemporary kitchen or bathroom, making an impression that other materials simply can't match.

We supply backpainted glass in virtually any colour with superb glass clarity thanks to our base material being a low iron float glass. We'll match any RAL, Syntha Pulvin or Dulux colour code as closely as we possibly can for perfect coordination in any room.

We work directly with homeowners, as well as kitchen and bathroom designers/installers, builders and architects, to advise on backpainted glass specification and the product's suitability for applications.

Backpainted glass is perfect for:

- kitchen splashbacks
- worktops
- feature panels for walls
- architrave
- skirting boards
- shower panels
- plus, almost any smooth, fixed element within the home



BACKPAINTED GLASS

Application, specification and installation guidance

With the colour coating on the reverse, the glass is easily cleaned, very durable and when painted on toughened glass is heat resistant to approximately 200 degrees Celsius – that's ideal for use behind an oven or wood burner.

Backpainted glass can be easily fixed to the wall with mirror adhesive (although products like Gripfill, No Nails, etc., must NOT be used under any circumstances). Alternatively, as long as it has been specified at the time of order, the glass can be drilled and screwed to the wall with dome top mirror screws.

Measure up where you need cut outs for sockets, switches, etc. before you place an order and we'll cut these ready for installation – complicated shapes can be accommodated too.

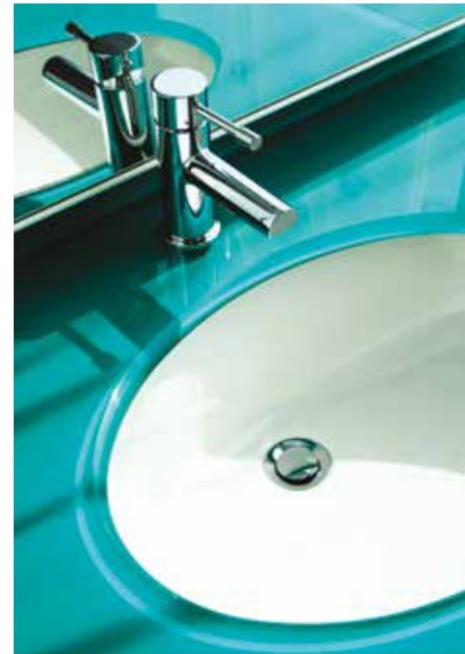

THE ADVANTAGES ARE CLEAR

PEACE OF MIND

Our highly experienced and skilled team provides you with the assurance that orders are handled efficiently, accurately and professionally from the moment we take your enquiry through to post-installation support.

Our manufacturing excellence is recognised by the fact that we are the only company in the UK licensed to manufacture ScreenLine® blinds in house. We use bespoke, precision engineered machinery to give a perfect finish every time and combine this with unrivalled craftsmanship. All our Uni-Blinds® operatives have been trained in Italy by Pellini to exacting standards in blind fabrication.

Every Uni-Blinds® unit is tested after fabrication to ensure smooth operation and trouble-free installation. This includes our 'plug n play' pre-wired boxes that are supplied with motorised Uni-Blinds®. And a final quality control check on every product is completed before dispatch.

All our Uni-Blinds® units carry a five year guarantee on the sealed units and integral blinds. External components have a two year guarantee.

All our Uni-Blinds® sealed units incorporate ScreenLine® blinds – this is the world's number one product of this kind. Morley Glass is in fact Europe's largest manufacturer of ScreenLine® blinds, reflecting the strength of our position in the integral blinds market and manufacturing expertise.



Facebook Reviews 4.6/5.0



Google Reviews 4.4/5.0

**review ratings correct as of June 2020*



YOUR OPINION MATTERS

"A job well done, a credit to British workmanship. I write in praise of Ian and Gavin for doing a fantastic job in affixing my window / integral blind. Both of your employees were courteous, efficient, and effective in carrying out their work. Well done Morley Blinds, a credit to the fenestration industry and British workmanship."

Frank Tudor

"Many thanks for all the help and assistance yesterday, the blinds are working perfectly. Can you please pass on my thanks to Ian in achieving a fully operational system."

"I would like to thank you for the excellent service I have received from your company. Thanks for sending your engineer down to look at the installation, he was able to fix one unit on-site and arranged for another unit to be manufactured to replace the other."

Advanced Alloys Limited

"Ian, many thanks for all the help and assistance yesterday I am very pleased that we now have the blinds working as the customer would normally expect. Can you please pass on my

thanks to Ian for his persistence in achieving a fully operational system. Once again many thanks for all the help."

Keith, Harmony Profiles

"In October I requested a brochure from yourselves, it was despatched promptly! I contacted my local dealer at Britannic Frames who came and measured my door for integrated blind glass. I found they were using another supplier who had a 6 week lead-in! I suggested they order my glass from you, which they did. Your lead in time was as you promised. Finally, they are fitted. It is absolutely perfect as regards letting more light into bungalow. Thank you!!"

Mrs L Leake

"Ian from Morley Glass came round today and not only did he fix the blind which had jammed he checked all the other blinds, replacing and servicing the cord mechanisms as necessary. It is rare these days for service to exceed expectations but Ian certainly managed that, please pass our thanks on."

Eamonn Sheil, Capital Windows, Doors & Conservatories



NATIONWIDE SERVICE AND DISTRIBUTION

Specialist support by our highly trained and friendly service engineers

As the only integral blind manufacturer in the UK with dedicated nationwide service engineering support, Morley Glass has worked extremely hard to guarantee our customers receive the best service at every step of their journey with us.

Given the huge popularity of our Uni-Blinds® integral blinds with today's homeowners, we understand why it's so important that our customers feel 100% confident when it comes to fitting them. That's why we advise, train and provide back-up for all Uni-Blinds® installers providing total peace of mind and confidence in the quality of the completed installation.

And, in the unlikely event of a customer encountering any technical issues with a Uni-Blinds® product, we'll guide you to the solution to make sure your reputation and service is enhanced, wherever you are in the UK.

Sharing our specialist knowledge

Our engineers are always happy to conduct site visits and support fabricators and installers in whichever ways we can. They offer an excellent after care service too.

From initial sales support right through to delivery and aftersales, our customers are never more than a phone call away from all the support they need to deliver the perfect window and door blind installation.

Uni-Blinds® are designed to be easy to fit by any competent window and door installer, including our motorised versions. But we understand that any new product will require a period to familiarise yourself. So, if you are new to Uni-Blinds®, don't worry we will help you achieve the perfect result from day one and assist installers on-site wherever possible.

Morley
GLASS & GLAZING LIMITED
Blinds

SAINT-GOBAIN

enLine

SOLUTIONS
SAINT-GOBAIN

akina

FORM



MORLEY GLASS NATIONWIDE

MORLEY GLASS NATIONWIDE

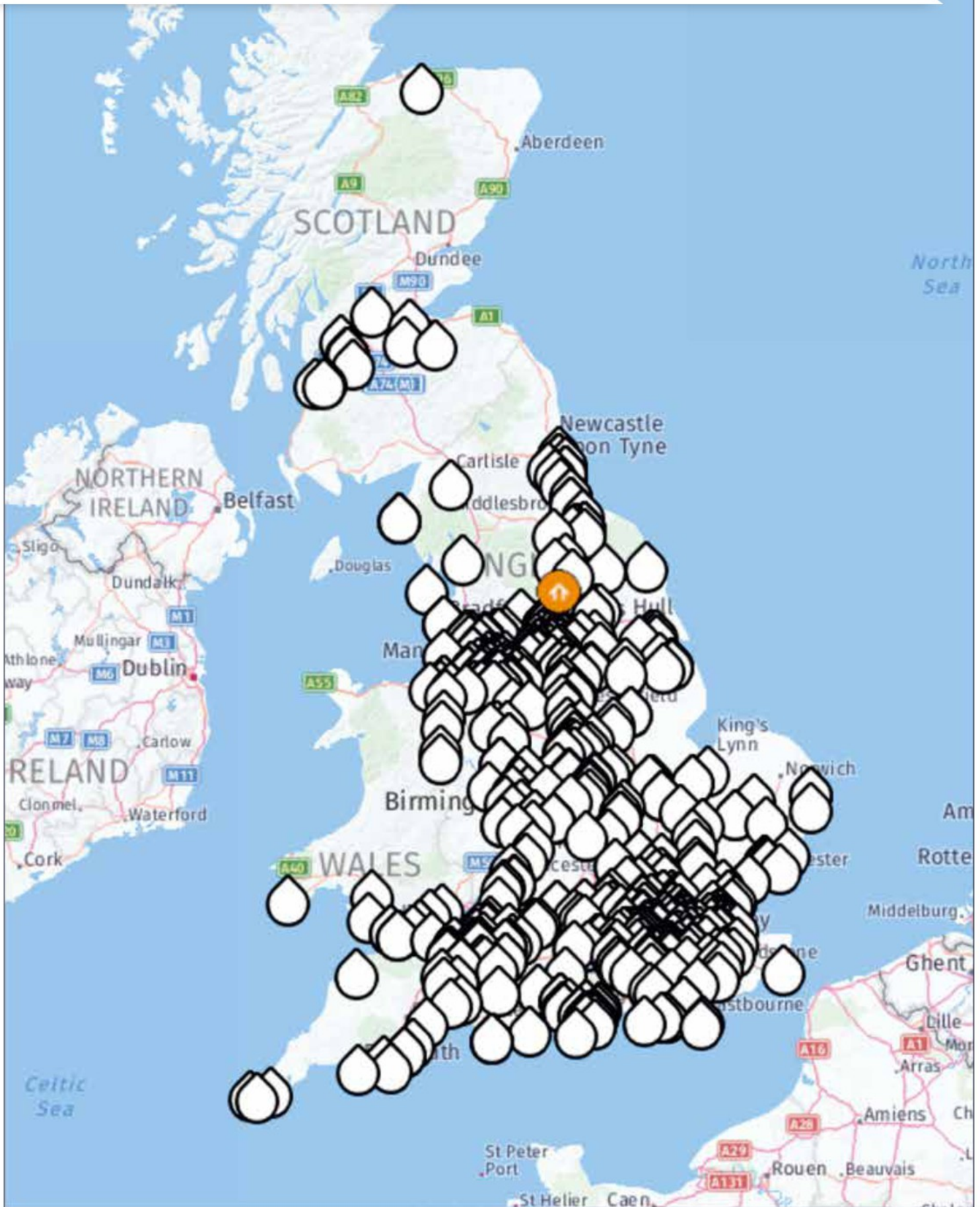

THE LARGEST RANGE OF ScreenLine® ACCESSORIES & SPARES

ScreenLine® accessories and spares when you need them fast.

Morley Glass stocks the biggest range of ScreenLine® accessories and spare parts in the UK. So, when you need a part for our Uni-Blinds® or any ScreenLine® integral blind system, we'll make sure you have it within 24 hours. As the largest ScreenLine® fabricator in the country, we have the benefit of regular daily deliveries from Pellini S.p.A.

From a replacement cord loop for the Uni-Blinds® C-System, to a pre-wired control box for our motorised MB System, we can cater for every requirement. You can view our full range of ScreenLine® accessories and spares at www.morleyglass.co.uk/accessories-spare where you can place your order too.

If you can't find what you are looking for or need any assistance with a Uni-Blinds® repair, please call us on 0113 277 8722 or email accessories@morleyglass.co.uk.

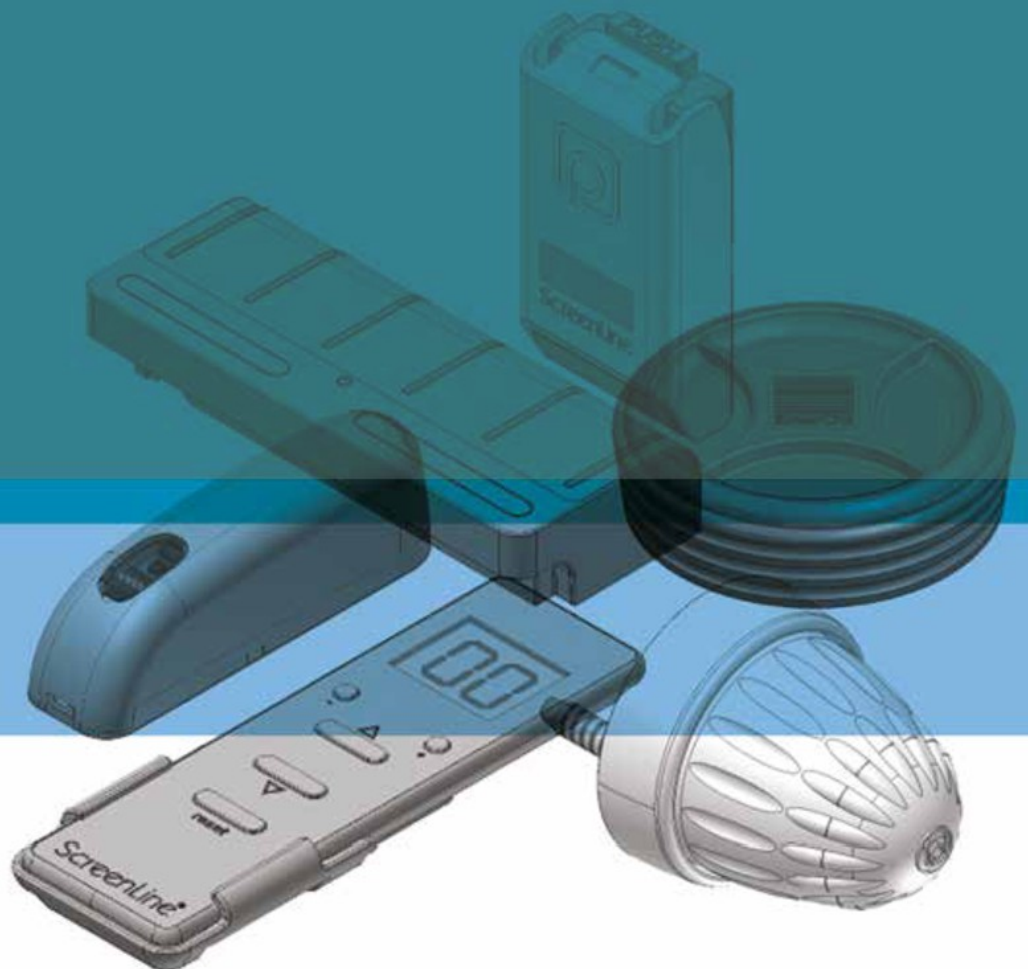

'The glass is always greener on the other side'

In addition to the benefits that Uni-Blinds® and our high performance glass units deliver in-use, Morley Glass products offer a number of important sustainability benefits.

Uni-Blinds® are manufactured and installed in the most environmentally sustainable way, with resource use minimised and energy efficiency optimised. But it is in the area of waste reduction that Morley Glass is pioneering an exciting new approach.

CRUSH - on-site glass recycling delivering social benefits

We have teamed up with Saint-Gobain Glass to install a glass crushing machine at our Leeds site. This enables us and our customers to recycle glass that is collected from old, post-consumer windows and doors. This utilises empty space on our vans returning from delivering more than 2000 sealed units with integral blinds inside every week to our customers.

But it's not just about reducing waste – the recycled glass that we supply back into the glass manufacturing process has a significant value, which we believe can benefit charities, schools and communities who may need our help to improve the environment.

That's why we've commissioned CRUSH - our customers and local tradespeople can give us their glass from old windows and doors, which we transform into cash for good causes. This is a free service which also helps our customers save money on the cost of skips and landfill taxes.

Local schools and charities across Yorkshire that focus on improving the environment can apply to us for a donation from the money we receive for the cullet, which could amount to £50,000 per year.



SUSTAINABILITY



UPCYCLING

As a UK manufacturer there are a number of sustainable resources from our supply chain which can be easily recycled or reused to create environmentally friendly products.

Wooden boxes

Some of the components used in the manufacture of our integral blinds are delivered to us in small wooden boxes. We have donated these boxes to local schools and community groups who have been exceedingly creative with them, finding new uses such as creating pieces of art, making time capsules, treasure chests and memory boxes, toy boxes and display cases – some of them are then sold and the money raised donated to charity.

Glass off-cuts

We donate our glass off-cuts to local glass artists Bob and Gael Spishak, who give them a new lease of life as works of art. Using their own home studio, the couple melt the glass down and reform it to produce stunning pieces of glass wear. Items they create include bowls, decorations and even a Nativity scene, all of which are subsequently either sold in aid of charity or donated to community groups.

We are always keen to hear from charities, schools and good causes in the Leeds and Yorkshire areas who may need our help. We can't promise to help everyone, but we will do our best.

COMMUNITY SUPPORT

SUPPORTING OUR LOCAL COMMUNITIES

Morley Glass is always striving to be a sustainable business which supports community initiatives, clubs and charities in Leeds and throughout Yorkshire.

Every year we sponsor a wide range of grass roots sports clubs, dance societies, youth clubs and other local and national charities. We do this because we understand the important role that we play in our local community, providing employment and supporting a local supply chain, but also being able to give something back.

We are always keen to hear from charities, schools and good causes in the Leeds and Yorkshire areas who may need our help. And whilst we can't promise to help everyone, we will do our best. It all adds up to our belief that if every business invested time and effort to give back to their local communities the world would be a much better place.



Community Action To Create Hope (CATCH)

This Harehills-based youth charity is made up of volunteers who want to make a positive difference in their local area. The charity's multifunctional community centre named 'ARK' in Harehills, Leeds provides activities for children and young people from all backgrounds. Its facilities include a gym for volunteers within what is now a first-rate community resource that is a fantastic example of what is possible when a community comes together to make positive changes.

Rotary Club of Roundhay North Leeds Charity Beer Festival

Organised by The Rotary Club of Roundhay, this annual festival encourages visitors to 'Drink Yorkshire' while raising money to fund worthwhile projects locally, nationally and worldwide. The two-day event features the best that Yorkshire has to offer, as well as gins distilled in the county. Since it began in 2012, the festival has raised almost £50k, enabling Roundhay Rotary to support charity projects including the installation of defibrillators outside local health centres and sponsoring Rotary Youth Leadership Awards.





Freedom 2 Dance

This Castleford-based charity provides dance opportunities for young people. It's fantastic scholarships, funded by Morley Glass, ensure budding dancers have their lessons funded for a 12-month period. Throughout the courses, children not only progress and perfect their dance steps and techniques, but they also develop greater confidence. The programme has most certainly made an impact and raised aspirations among the dancers, which has supported our aim to encourage children to aspire to work hard and achieve more!



Variety

Variety provides coaches, wheelchairs and grants for specialist equipment to children and schools across the UK, as well as funding days out for disadvantaged children via its Great Days Out Programme. As part of our support, we raised funds for Variety to provide a Sunshine Variety Coach to Mill Field Primary School in Leeds. This enables activities to be planned without transport concerns and allows students – including two wheelchair users – to benefit from greater access to their communities, as well as the opportunity to engage in extra-curricular activities.



CALL OUR EXPERT AND FRIENDLY TEAM: 0113 277 8722

Mon - Fri 07:30 - 16:30

All technical information is available
on our website: morleyglass.co.uk



Uni-Blinds®

Innovation comes built-in



Morley
GLASS & GLAZING LTD

Morley Glass
Unit 3 Leeds 27 Industrial Estate,
Bruntcliffe Way, Leeds, LS27 0HH
Email: info@morleyglass.co.uk
Tel: 0113 277 8722
Fax: 0113 277 8723